

Technical Guidance Reference N11 to N42

N

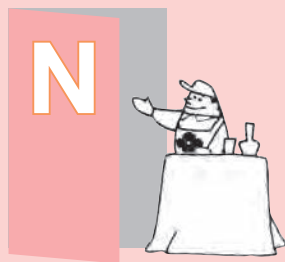

Technical Guidance

Turning Edition	N12
Milling Edition	N17
Endmilling Edition	N21
Drilling Edition	N24
SUMIBORON Edition	N29

References

SI Unit Conversion List	N33
Metals Symbols Chart (Excerpt)	N34
Steel and Non-Ferrous Metal Symbol Chart (Excerpt) ...	N36
Hardness Scale Comparison Chart	N37
Dimensional Tolerance of Standard Fittings	N38
Dimensional Tolerance and Fittings	N40
Standard of Tapers	N41
Surface Roughness	N42

The Basics of Turning, Turning Edition

Calculating Cutting Speed

(1) Calculating rotation speed from cutting speed

$$n = \frac{1,000 \times v_c}{\pi \times D_m}$$

n : Spindle Speed (min⁻¹)
 v_c : Cutting speed (m/min)
 D_m : Inner/outer diameter of workpiece (mm)
 π : ≈ 3.14

Example: $v_c=150$ m/min, $D_m=100$ mm

$$n = \frac{1,000 \times 150}{3.14 \times 100} = 478 \text{ (min}^{-1}\text{)}$$

(2) Calculating cutting speed from rotational speed

$$v_c = \frac{\pi \times D_m \times n}{1,000}$$

Refer to the above table

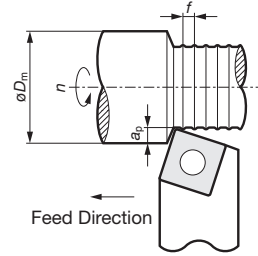

- n : Spindle speed (min⁻¹)
- v_c : Cutting speed (m/min)
- f : Feed rate per revolution (mm/rev)
- a_p : Depth of cut (mm)
- D_m : Diameter of workpiece (mm)

Calculating Power Requirements

$$P_c = \frac{v_c \times f \times a_p \times k_c}{60 \times 10^3 \times \eta}$$

$$H = \frac{P_c}{0.75}$$

P_c : Power requirements (kW)
 v_c : Cutting speed (m/min)
 f : Feed Rate (mm/rev)
 a_p : Depth of cut (mm)
 k_c : Specific cutting force (MPa)
 H : Required horsepower (HP)
 η : Machine efficiency (0.70 to 0.85)

Rough value of k_c

- Aluminum: 800MPa
- General steel: 2,500 to 3,000MPa
- Cast iron: 1,500MPa

Three cutting force components

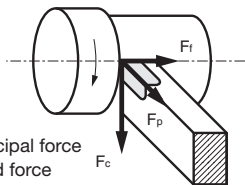

F_c : Principal force
 F_t : Feed force
 F_p : Back force

Calculating cutting force

$$P = \frac{k_c \times q}{1,000}$$

$$= \frac{k_c \times a_p \times f}{1,000}$$

P : Cutting force (kN)
 k_c : Specific cutting force (MPa)
 q : Chip area (mm²)
 a_p : Depth of Cut (mm)
 f : Feed Rate (mm/rev)

Relation between cutting speed and cutting force

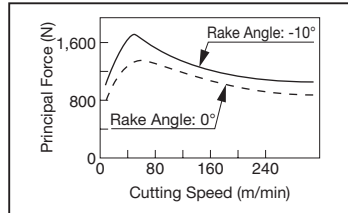

Relation between rake angle and cutting force

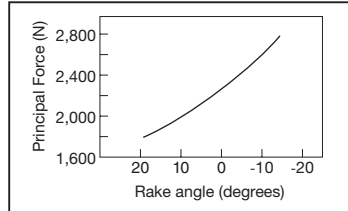

Relation between feed rate and specific cutting force (for carbon steel)

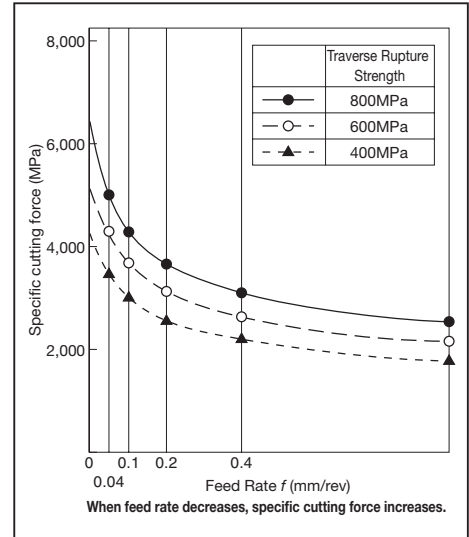

Machined Surface Roughness

Theoretical (geometrical) surface roughness

$$h = \frac{f^2}{8 \times RE} \times 10^3$$

h : Theoretical surface roughness (μ m)
 f : Feed rate per revolution (mm/rev)
 RE : Corner radius (mm)

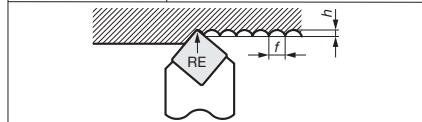

Actual surface roughness

- Steel:
Theoretical surface roughness $\times 1.5$ to 3
- Cast iron:
Theoretical roughness $\times 3$ to 5

Ways to improve surface finish roughness

- (1) Use an insert with a larger corner radius.
- (2) Optimise the cutting speed and feed rate so that built-up edges do not occur.
- (3) Select an appropriate insert grade.
- (4) Use wiper insert.

Relation between corner radius and 3-part force

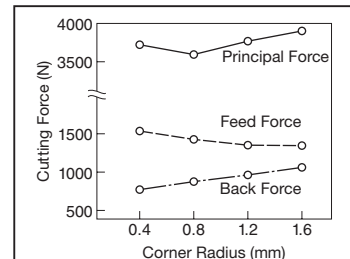

Large corner radius increases back force.

Work Material: SCM440 (38HS)
 Insert: TNGA2204SS
 Holder: PTGNR2525-43
 Cutting Conditions: $v_c=100$ m/min,
 $a_p=4$ mm,
 $f=0.45$ mm/rev

Forms of Tool Failure and Tool Life, Turning Edition

Forms of Tool Failure

	Classification	No.	Name of Failure	Major Causes of Failure
	Failure Caused by Mechanical Factors	(1) to (5) (6) (7)	Flank Wear Chipping Fracture	Wear caused by the scratching effect of hard grains contained in the work material Fine breakages caused by high cutting loads or vibration Large breakage caused by the impact of an excessive mechanical force acting on the cutting edge
Failure Caused by Thermal and Chemical Reactions	(8) (9) (10) (11)	Crater wear Plastic deformation Thermal cracking Built-up edges	Cutting chips removing tool material as it flows over its top rake at high temperatures Deformation of cutting edge due to softening at high temperatures Fatigue from rapid, repeated heating and cooling cycles during interrupted cutting Work material is pressure welded on the top face of the cutting edge	

Tool Wear Curve

Forms of Tool Wear

Flank wear	Crater wear on rake face
· Wear increases rapidly right after starting cutting, then moderately and proportionally, and then rapidly again after a certain value.	· Wear increases proportionately to the cutting time.

Tool Life (V-T)

This double logarithm graph shows the relative tool life (T) with the specified wear over a range of cutting speeds (V_c) on the X axis, and the cutting speed along the Y axis.



	Flank Wear	Crater wear
Tool wear		
Tool life		

■ Insert Failure and Countermeasures







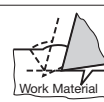
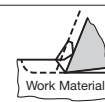



Insert Failure	Cause	Countermeasures
<p>Flank Wear</p> 	<ul style="list-style-type: none"> · Tool grade lacks wear resistance. · Cutting speed is too fast. · Feed rate is far too slow. 	<ul style="list-style-type: none"> · Select a more wear-resistant grade. P30→P20→P10 K20→K10→K01 · Increase rake angle. · Decrease cutting speed. · Increase feed rate.
<p>Crater wear</p> 	<ul style="list-style-type: none"> · Tool grade lacks crater wear resistance. · Rake angle is too small. · Cutting speed is too fast. · Feed rate and depth of cut are too large. 	<ul style="list-style-type: none"> · Select a more crater wear-resistant grade. · Increase rake angle. · Change the chipbreaker. · Decrease cutting speed. · Reduce feed rate and depth of cut.
<p>Cutting Edge Chipping</p> 	<ul style="list-style-type: none"> · Tool grade lacks toughness. · Cutting edge breaks due to chip adhesion. · Cutting edge is not strong enough. · Feed rate and depth of cut are too large. 	<ul style="list-style-type: none"> · Select a tougher grade. P10→P20→P30 K01→K10→K20 · Increase amount of honing on cutting edge. · Reduce rake angle. · Reduce feed rate and depth of cut.
<p>Cutting Edge Fracture</p> 	<ul style="list-style-type: none"> · Tool grade lacks toughness. · Cutting edge is not strong enough. · Holder is not strong enough. · Feed rate and depth of cut are too large. 	<ul style="list-style-type: none"> · Select a tougher grade. P10→P20→P30 K01→K10→K20 · Select a chipbreaker with a strong cutting edge. · Select a holder with a larger approach angle. · Select a holder with a larger shank size. · Reduce feed rate and depth of cut.
<p>Adhesion/Built-up Edges</p> 	<ul style="list-style-type: none"> · Inappropriate grade selection. · Cutting edge is not sharp enough. · Cutting speed is too slow. · Feed rate is too slow. 	<ul style="list-style-type: none"> · Select a grade with less affinity to the work material. Coated carbide or cermet grades. · Select a grade with a smooth coating. · Increase rake angle. · Reduce honing. · Increase cutting speed. · Increase feed rate.
<p>Plastic Deformation</p> 	<ul style="list-style-type: none"> · Tool grade lacks thermal resistance. · Cutting speed is too fast. · Feed rate and depth of cut are too large. · Not enough coolant. 	<ul style="list-style-type: none"> · Select a more crater wear-resistant grade. · Increase rake angle. · Decrease cutting speed. · Reduce feed rate and depth of cut. · Supply sufficient coolant.
<p>Notch wear</p> 	<ul style="list-style-type: none"> · Tool grade lacks wear resistance. · Rake angle is too small. · Cutting speed is too fast. 	<ul style="list-style-type: none"> · Select a more wear-resistant grade. P30→P20→P10 K20→K10→K01 · Increase rake angle. · Alter depth of cut to shift the notch location.

Chip Control and Countermeasures, Turning Edition

■ Type of Chip Generation

	Flowing	Shearing	Tearing	Cracking
Type				
Condition	Continuous chips with good surface finish.	Chip is sheared and separated by the shear angle.	Chips appear to be torn from the surface.	Chips crack before reaching the cutting point.
Application	General cutting of steel and light alloy	Steel, stainless steel (low speed)	Steel, cast iron (very low speed, very small feed rate)	Cutting of general cast iron and carbon
Influence factor	Large ← Deformation of work material → Small Large ← Rake angle → Small Small ← Depth of cut → Large Large ← Cutting speed → Small			

■ Type of chip control

Classification of chip shapes	Depth of Cut	A	B	C	D	E
	Large					
Small						
Evaluation	NC lathe (for automation)	×	×	○	○	△
	General-purpose lathe (for safety)	×	○	○	○ to △	×

Good: C type, D type
 Poor: A type: Twines around the tool or workpiece, damaging the machined surface and affecting safety.
 B type: Causes problems in the automatic chip conveyor and chipping occurs easily.
 E type: Causes spraying of chips and poor surface finish due to chattering, along with chipping, large cutting force and high temperatures.

■ Factor of improvement of chip control

(1) Increase feed rate (f)

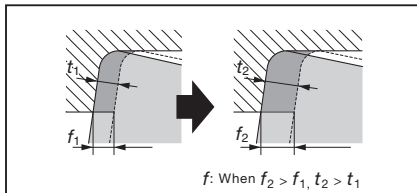

When the feed rate increases, the chip thickness (t) increases and chip control improves.

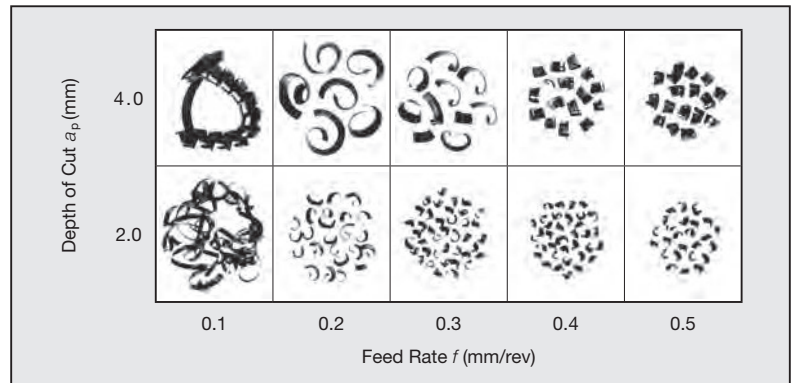

(2) Decrease side cutting edge (θ°)

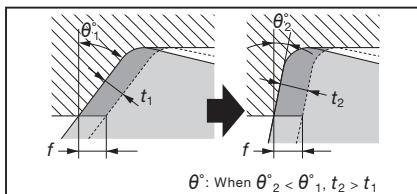

Even if the feed rate is the same, a smaller side cutting edge angle makes chips thicker and chip control improves.

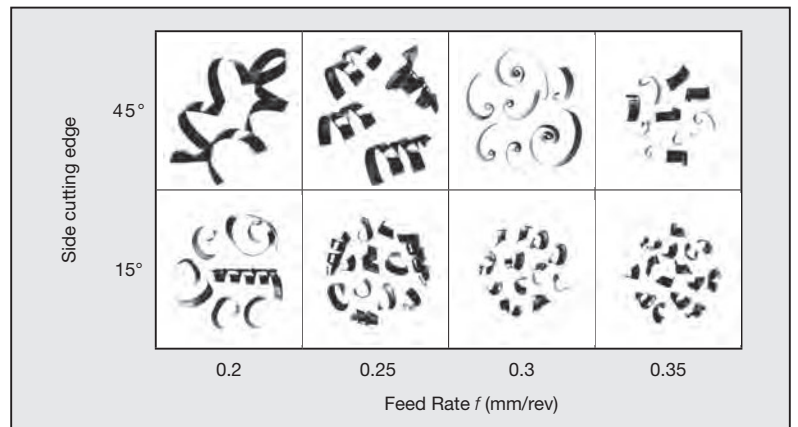

(3) Reduce corner radius (RE)

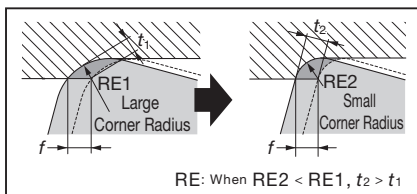

Even if the feed rate is the same, a smaller corner radius makes chips thicker and chip control improves.

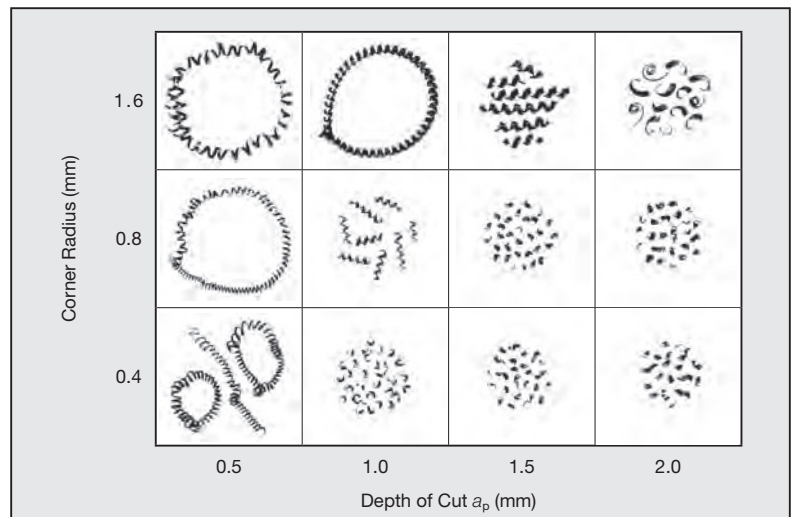

* Cutting force increases proportionately to the length of the contact surface. Therefore, a larger corner radius increases back force which induces chattering. A smaller corner radius produces a rougher surface finish at the same feed rate.

The Basics of Threading, Turning Edition

Thread Cutting Methods

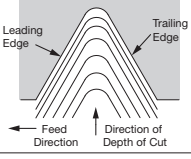
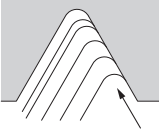
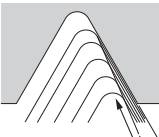
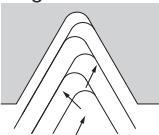
Cutting Method	Features
<p>Radial Infeed</p> 	<ul style="list-style-type: none"> · Most common threading technique, used mainly for small pitch threads. · Easy to change cutting conditions such as depth of cut, etc. · Long contact point has a tendency to chatter. · Chip control is difficult. · Considerable damage tends to occur on the trailing edge side.
<p>Flank Infeed</p> 	<ul style="list-style-type: none"> · Effective for large-pitch threads and blemish-prone work material surfaces. · Chips evacuate from one side for good chip control. · The trailing edge side is worn, and therefore the flank is easily worn.
<p>Modified Flank Infeed</p> 	<ul style="list-style-type: none"> · Effective for large-pitch threads and blemish-prone work material surfaces. · Chips evacuate from one side for good chip control. · Inhibits flank wear on trailing edge side.
<p>Alternating Flank Infeed</p> 	<ul style="list-style-type: none"> · Effective for large-pitch threads and blemish-prone work material surfaces. · Wears evenly on right and left cut edges. · Since both edges are used alternately, chip control is sometimes difficult.

Troubleshooting for Threading

	Failure	Cause	Countermeasures
Cutting Edge Failure	Excessive Wear	· Tool grade	· Select a more wear-resistant grade
		· Cutting conditions	· Reduce cutting speed · Use a suitable quantity and concentration of coolant · Change the number of passes
	Uneven Wear on Right and Left Sides	· Tool mounting	· Check whether the cutting edge inclination angle is appropriate for the thread lead angle · Check whether the tool is mounted properly
		· Cutting conditions	· Change to modified flank infeed or alternating flank infeed
	Chipping	· Cutting conditions	· If built-up edge occurs, increase the cutting speed
Fracture	· Biting of chips	· Supply enough coolant to the cutting edge	
	· Cutting conditions	· Increase the number of passes and reduce the depth of cut for each pass · Use separate tools for roughing and finishing	
Shape and Accuracy	Poor surface finish roughness	· Cutting conditions	· If blemished due to low-speed machining, increase the cutting speed · If chattering occurs, decrease the cutting speed · If the depth of cut of the final pass is too small, make it larger
		· Tool grade	· Select a more wear-resistant grade
		· Inappropriate cutting edge inclination angle	· Select the correct shim to ensure relief on the side of the insert
	Inappropriate Thread Shape	· Tool mounting	· Check whether the tool is mounted properly
	Shallow Thread Depth	· Shallow depth of cut	· Check the depth of cut
· Tool wear		· Check damage to the cutting edge	

The Basics of Milling, Milling Edition

■ Parts

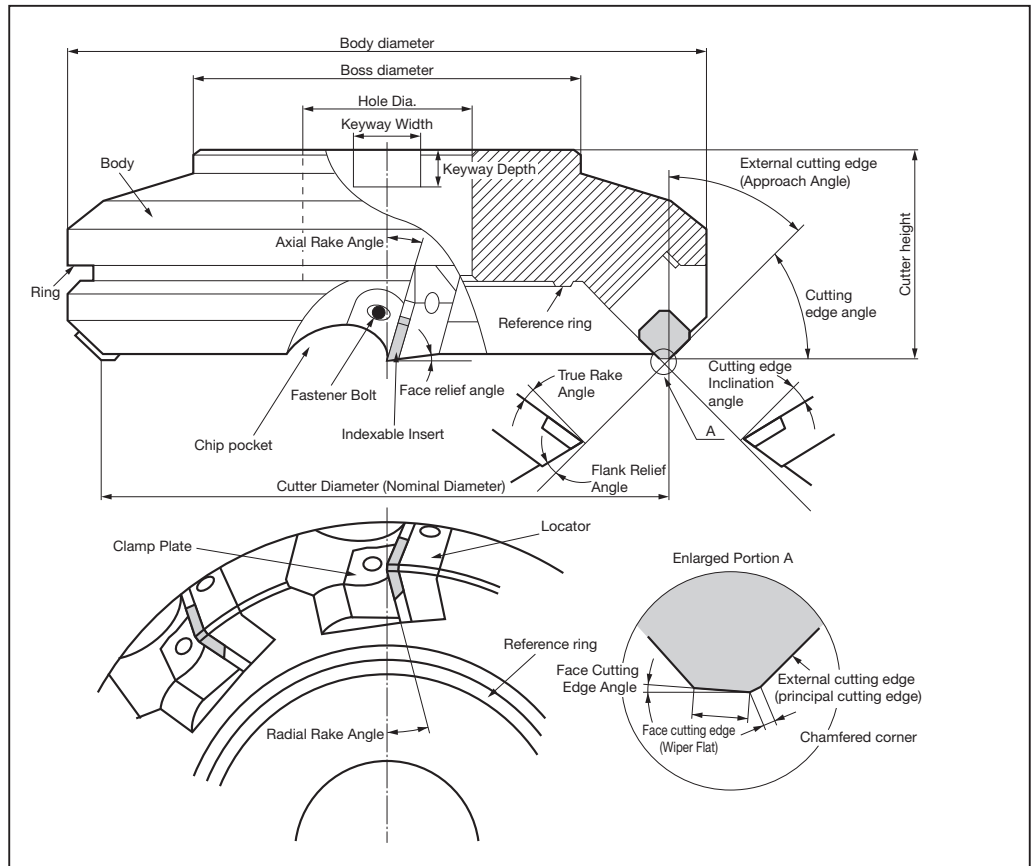

■ Milling Calculation Formulas

● Calculating cutting speed

$$v_c = \frac{\pi \times DC \times n}{1,000}$$

$$n = \frac{1,000 \times v_c}{\pi \times DC}$$

v_c : Cutting speed (m/min)
 π : ≈ 3.14
 DC: Nominal cutting diameter (mm)
 n : Rotation speed (min^{-1})

● Calculating feed rate

$$v_f = f_z \times z \times n$$

$$f_z = \frac{v_f}{z \times n}$$

v_f : Feed rate per minute (mm/min)
 f_z : Feed rate per tooth (mm/t)
 z : Number of teeth

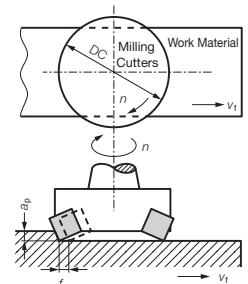

● Calculating Power Requirements

$$P_c = \frac{a_e \times a_p \times v_f \times k_c}{60 \times 10^3 \times \eta} = \frac{Q \times k_c}{60 \times 10^3 \times \eta}$$

● Horsepower Requirement

$$H = \frac{P_c}{0.75}$$

● Chip evacuation amount

$$Q = \frac{a_e \times a_p \times v_f}{1,000}$$

P_c : Power consumption (kw)
 H : Required horsepower (HP)
 Q : Chip evacuation amount (cm^3/min)
 a_e : Cutting width (mm)
 v_f : Feed rate per minute (mm/min)
 a_p : Depth of cut (mm)
 k_c : Cutting force (MPa)
 Rough values (Steel: 2,500 to 3,000MPa)
 (Cast iron: 1,500MPa)
 (Aluminum: 800MPa)
 η : Machine efficiency (about 0.75)

● Relation between feed rate, work material and specific cutting force

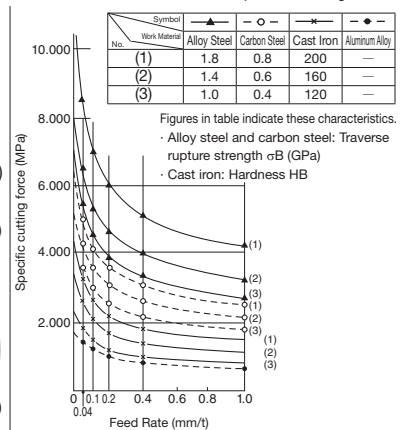

Functions of cutting edge angles

	Material	Symbol	Function	Effect
(1)	Axial rake angle	A.R.	Determines chip evacuation direction, adhesion, thrust, etc.	Available in positive to negative (large to small) rake angles. Typical combinations: Positive and Negative, Positive and Positive, Negative and Negative
(2)	Radial rake angle	R.R.		
(3)	Approach angle	A.A.	Determines chip thickness and chip evacuation direction	Large: Thin chips Small cutting force
(4)	True rake angle	T.A.	Effective rake angle	Positive (Large): Excellent machinability and low chip adhesion. Low cutting edge strength. Negative (Small): Strong cutting edge and easy chip adhesion.
(5)	Cutting edge inclination angle	I.A.	Determines chip control direction	Positive (Large): Excellent chip control and small cutting force. Low cutting edge strength.
(6)	Face cutting edge angle	F.A.	Determines surface finish roughness	Small: Excellent surface roughness.
(7)	Relief angle		Determines cutting edge strength, tool life, chattering	

True rake angle (T.A.) table

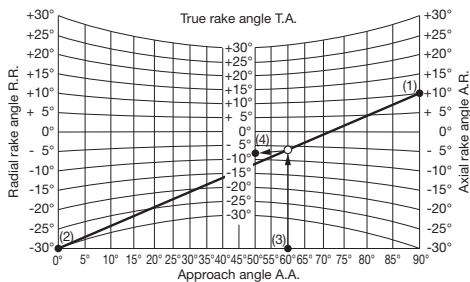

Example: (1) A.R. (Axial rake angle) = +10° } -> (4)
 (2) R.R. (Radial rake angle) = -30° } T.A. (True rake angle) = -8°
 (3) A.A. (Approach angle) = 60°

Formula: $\tan T.A. = \tan R.R. / \cos A.A. + \tan A.R. / \sin A.A.$

Inclination angle (I.A.) chart

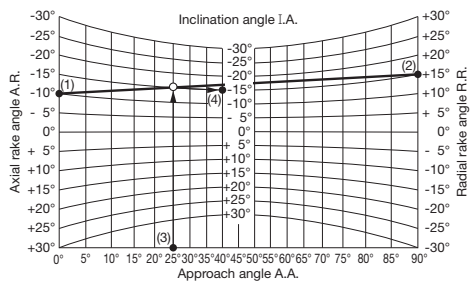

Example: (1) A.R. (Axial rake angle) = -10° } -> (4)
 (2) R.R. (Radial rake angle) = +15° } I.A. (inclination angle) = -15°
 (3) A.A. (Approach angle) = 25°

Formula: $\tan I.A. = \tan A.R. / \cos A.A. - \tan R.R. / \sin A.A.$

Rake angle combination and features

	Double Positive type	Negative - Positive type	Double Negative type
Edge combination and chip evacuation (A.R.: Axial rake angle R.R.: Radial rake angle) ↻ : Chip and evacuation direction ↺ : Cutter rotation direction			
Advantages	Good sharpness	Excellent chip evacuation and sharpness	Economical design enabling use of both sides of insert Strong cutting edge
Disadvantages	Only single-sided inserts with a lower cutting edge strength can be used	Only single-sided inserts can be used	Dull cutting action
Applications	Machining of aluminum alloy and other materials requiring sharpness	Machining of steel, cast iron, and stainless steel, with suitable strength and good evacuation	For hard materials such as cast iron or poor surfaces such as castings
Cat. No.	ANX Type, HF Type, WAX Type	WGX Type, WFX Type, RSX Type, MSX Type	TSX Type, DGC Type, DFC Type, DNX Type
Chips (Ex.) (Work material: SCM435 v _c =130m/min f _z =0.23mm/t a _p =3mm)			

The Basics of Milling, Milling Edition

Relation between engagement angle and tool life

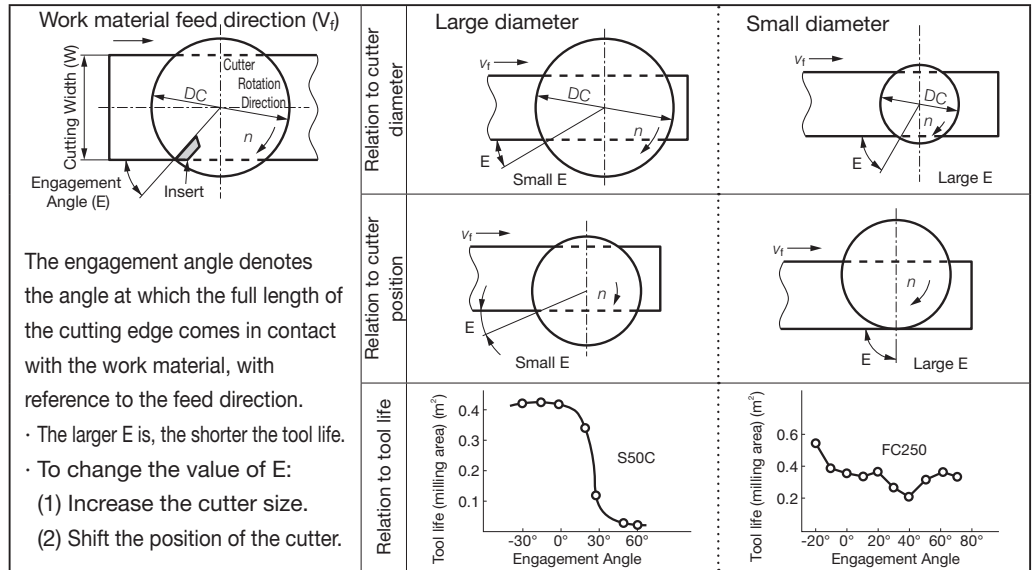

Relation between the number of simultaneously engaged cutting edges and cutting force

Normally, a cutting width 70 to 80% of the cutter diameter is considered appropriate, as shown in example d). However, this may not apply due to the actual rigidity of the machine or workpiece, and the machine horsepower.

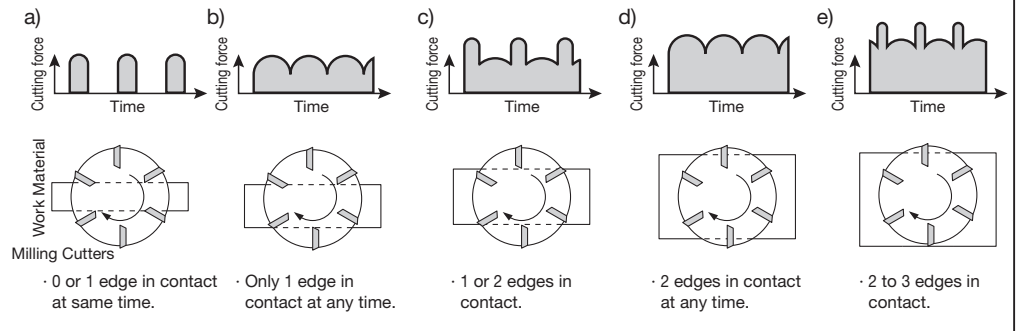

Improving surface roughness

(1) Inserts with wiper flat

- When all of the cutting edges have wiper flats, a few teeth protrude due to inevitable runout and act as wiper inserts.
- Insert equipped with straight wiper flat
 - Insert equipped with curved wiper flat (Face angle: Around 15' to 1°)
 - Insert equipped with curved wiper flat (Curvature: $\approx R500$ (example))

(2) Wiper insert assembling system

A system in which one or two inserts (wiper inserts) protrude with a smooth curved edge just a little beyond the other teeth to wipe the milled surface. (Applicable to WGX Type, DGC Type, etc.)

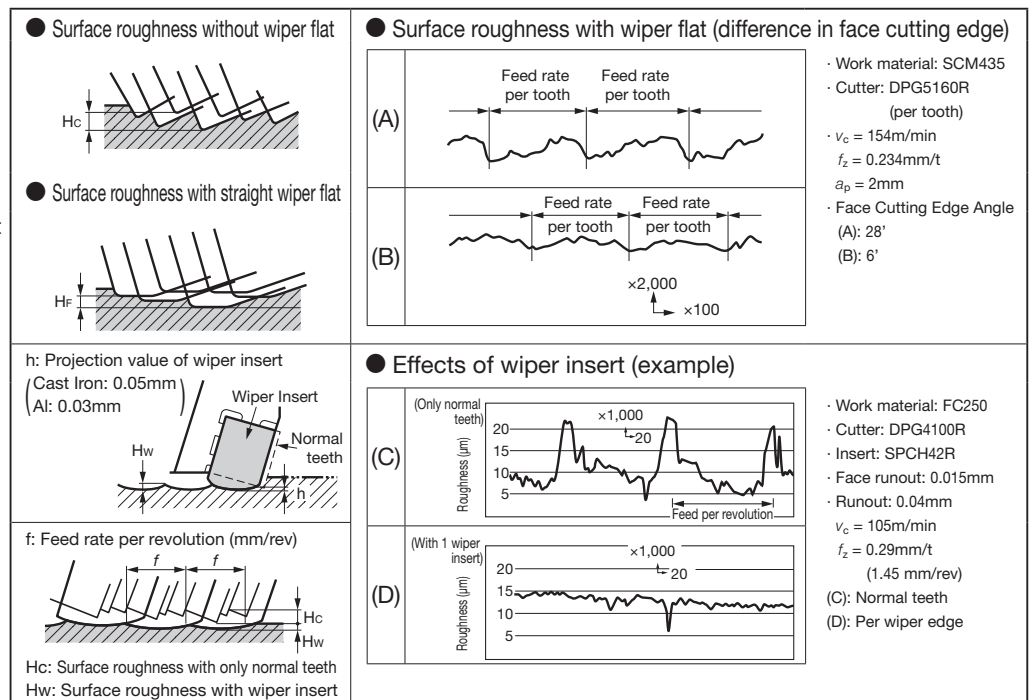

Troubleshooting for Milling, Milling Edition

■ Troubleshooting for Milling

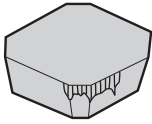
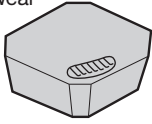
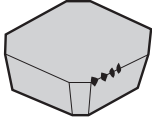
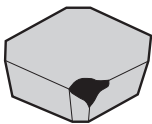
Failure	Basic Remedies		Countermeasure Examples														
Cutting Edge Failure	Excessive Flank Wear 	Tool Grade Cutting Conditions	<ul style="list-style-type: none"> Select a more wear-resistant grade. Carbide (P30→P20) → { Coated, Cermet } K20→K10 Decrease the cutting speed. Increase feed rate. 	<ul style="list-style-type: none"> Recommended Insert Grade <table border="1"> <thead> <tr> <th></th> <th>Steel</th> <th>Cast Iron</th> <th>Non-Ferrous Alloy</th> </tr> </thead> <tbody> <tr> <td>Finishing</td> <td>T250A, T4500A (Cermet)</td> <td>ACK100 (Coated) BN7000 (SUMIBORON)</td> <td>DA1000 (SUMIDIA)</td> </tr> <tr> <td>Roughing</td> <td>ACP100 (Coated)</td> <td>ACK200 (Coated)</td> <td>DL1000 (Coated)</td> </tr> </tbody> </table> 		Steel	Cast Iron	Non-Ferrous Alloy	Finishing	T250A, T4500A (Cermet)	ACK100 (Coated) BN7000 (SUMIBORON)	DA1000 (SUMIDIA)	Roughing	ACP100 (Coated)	ACK200 (Coated)	DL1000 (Coated)	
		Steel	Cast Iron	Non-Ferrous Alloy													
	Finishing	T250A, T4500A (Cermet)	ACK100 (Coated) BN7000 (SUMIBORON)	DA1000 (SUMIDIA)													
	Roughing	ACP100 (Coated)	ACK200 (Coated)	DL1000 (Coated)													
	Excessive Crater Wear 	Tool Grade Tool Design Cutting Conditions	<ul style="list-style-type: none"> Select a crater-resistant grade. Use a sharp chipbreaker. (G → L) Decrease the cutting speed. Reduce depth of cut and feed rate. 	<ul style="list-style-type: none"> Recommended Insert Grade <table border="1"> <thead> <tr> <th></th> <th>Steel</th> <th>Cast Iron</th> <th>Non-Ferrous Alloy</th> </tr> </thead> <tbody> <tr> <td>Finishing</td> <td>T250A, T4500A (Cermet)</td> <td>ACK100 (Coated)</td> <td>DA1000 (SUMIDIA)</td> </tr> <tr> <td>Roughing</td> <td>ACP100 (Coated)</td> <td>ACK200 (Coated)</td> <td>DL1000 (Coated)</td> </tr> </tbody> </table> 		Steel	Cast Iron	Non-Ferrous Alloy	Finishing	T250A, T4500A (Cermet)	ACK100 (Coated)	DA1000 (SUMIDIA)	Roughing	ACP100 (Coated)	ACK200 (Coated)	DL1000 (Coated)	
	Steel	Cast Iron	Non-Ferrous Alloy														
Finishing	T250A, T4500A (Cermet)	ACK100 (Coated)	DA1000 (SUMIDIA)														
Roughing	ACP100 (Coated)	ACK200 (Coated)	DL1000 (Coated)														
Chipping 	Tool Grade Tool Design Cutting Conditions	<ul style="list-style-type: none"> Use a tougher grade. P10→P20→P30 K01→K10→K20 Select a negative/positive cutter with a large peripheral cutting edge angle (a small approach angle). Reinforce the cutting edge (honing). Select a stronger chipbreaker. (G → H) Reduce feed rate. 	<ul style="list-style-type: none"> Recommended Insert Grade <table border="1"> <thead> <tr> <th></th> <th>Steel</th> <th>Cast Iron</th> </tr> </thead> <tbody> <tr> <td>Finishing</td> <td>ACP200 (Coated)</td> <td>ACK200 (Coated)</td> </tr> <tr> <td>Roughing</td> <td>ACP300 (Coated)</td> <td>ACK300 (Coated)</td> </tr> </tbody> </table> Recommended cutter: SEC-WaveMill WGX Type Cutting conditions: Refer to H20 		Steel	Cast Iron	Finishing	ACP200 (Coated)	ACK200 (Coated)	Roughing	ACP300 (Coated)	ACK300 (Coated)					
	Steel	Cast Iron															
Finishing	ACP200 (Coated)	ACK200 (Coated)															
Roughing	ACP300 (Coated)	ACK300 (Coated)															
Fracture 	Tool Grade Tool Design Cutting Conditions	<ul style="list-style-type: none"> If it is due to excessive low speeds or very low feed rates, select a grade resistant to adhesion. If the cause is thermal cracking, select a thermal impact resistant grade. Select a negative/positive (or double negative) cutter type with a large peripheral cutting edge angle (a small approach angle). Reinforce the cutting edge (honing). Select a stronger chipbreaker. (G → H) Increase insert size (thickness in particular). Select appropriate conditions for that particular application. 	<ul style="list-style-type: none"> Recommended Insert Grade <table border="1"> <thead> <tr> <th></th> <th>Steel</th> <th>Cast Iron</th> </tr> </thead> <tbody> <tr> <td>Roughing</td> <td>ACP300 (Coated)</td> <td>ACK300 (Coated)</td> </tr> </tbody> </table> Recommended cutter: SEC-WaveMill WGX Type Insert Thickness: 3.18 → 4.76mm Chipbreaker type: Standard → Strong edge type Cutting conditions: Refer to H20 		Steel	Cast Iron	Roughing	ACP300 (Coated)	ACK300 (Coated)								
	Steel	Cast Iron															
Roughing	ACP300 (Coated)	ACK300 (Coated)															
Unsatisfactory Machined Surface Finish	Tool Grade Tool Design Cutting Conditions	<ul style="list-style-type: none"> Select an adhesion-resistant grade. Carbide → Cermet Improve axial runout of cutting edges. (Use a cutter with less runout) (Mount the correct insert) Use a wiper insert. Use cutters dedicated for finishing. Increase the cutting speed. 	<ul style="list-style-type: none"> Recommended Cutters and Insert Grades <table border="1"> <thead> <tr> <th></th> <th></th> <th>Steel</th> <th>Cast Iron</th> <th>Non-Ferrous Alloy</th> </tr> </thead> <tbody> <tr> <td rowspan="2">General-purpose</td> <td>Cutter</td> <td>WGX Type* ACP200 (Coated)</td> <td>DGC Type ACK200 (Coated)</td> <td>ANX Type* DA1000 (SUMIDIA)</td> </tr> <tr> <td>Insert</td> <td>WGX Type T4500A (Cermet)</td> <td>FMU Type BN7000 (SUMIBORON)</td> <td>ANX Type DA1000 (SUMIDIA)</td> </tr> </tbody> </table> Cutters marked with * can be mounted with wiper inserts. 			Steel	Cast Iron	Non-Ferrous Alloy	General-purpose	Cutter	WGX Type* ACP200 (Coated)	DGC Type ACK200 (Coated)	ANX Type* DA1000 (SUMIDIA)	Insert	WGX Type T4500A (Cermet)	FMU Type BN7000 (SUMIBORON)	ANX Type DA1000 (SUMIDIA)
		Steel	Cast Iron	Non-Ferrous Alloy													
General-purpose	Cutter	WGX Type* ACP200 (Coated)	DGC Type ACK200 (Coated)	ANX Type* DA1000 (SUMIDIA)													
	Insert	WGX Type T4500A (Cermet)	FMU Type BN7000 (SUMIBORON)	ANX Type DA1000 (SUMIDIA)													
Others	Chattering	Tool Design Cutting Conditions Others	<ul style="list-style-type: none"> Select a cutter with sharp cutting edges. Use an irregular pitched cutter. Reduce the feed rate. Improve the rigidity of the workpiece and cutter clamp. 	<ul style="list-style-type: none"> Recommended cutter For steel: SEC-WaveMill WGX Type For cast iron: SEC-Sumi Dual Mill DGC Type For light alloy: High-efficiency PCD Cutter for Aluminum Alloys ANX Type 													
	Unsatisfactory Chip Control	Tool Design	<ul style="list-style-type: none"> Select a cutter with good chip evacuation features. Reduce number of teeth. Use a wide chip pocket. 	<ul style="list-style-type: none"> Recommended cutter: SEC-WaveMill WGX Type 													
	Edge Chipping On Workpiece	Tool Design Cutting Conditions	<ul style="list-style-type: none"> Increase the peripheral cutting edge angle (decrease the approach angle). Change the chipbreaker blade type. (G → L) Reduce the feed rate. 	<ul style="list-style-type: none"> Recommended cutter: SEC-WaveMill WGX Type 													
	Burr formation	Tool Design Cutting Conditions	<ul style="list-style-type: none"> Use a sharp-edged cutter. Increase feed rate. Use a burr-proof insert. 	<ul style="list-style-type: none"> Recommended cutter: SEC-WaveMill WGX Type + FG Chipbreaker SEC-Sumi Dual Mill DGC Type + FG Chipbreaker 													

■ Parts

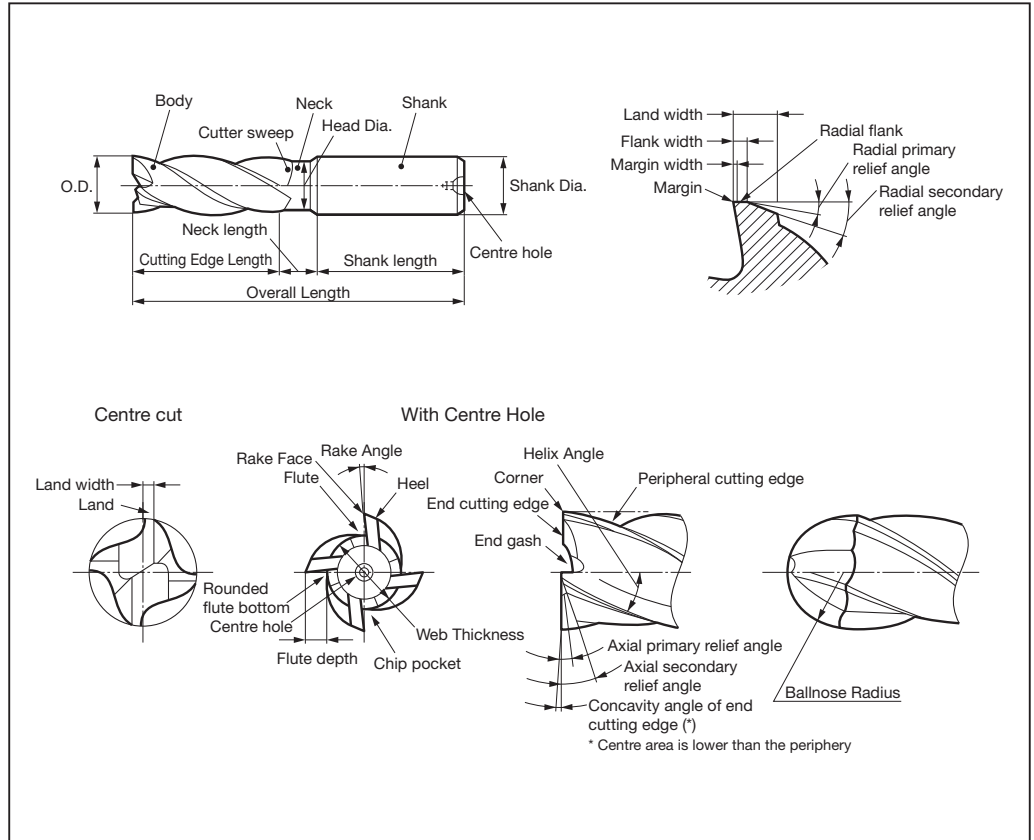

■ Calculating cutting conditions (square endmill)

● Calculating cutting speed

$$v_c = \frac{\pi \times DC \times n}{1,000} \quad n = \frac{1,000 \times v_c}{\pi \times DC}$$

● Calculating feed rate per revolution and per tooth

$$v_f = n \times f \quad f = \frac{v_f}{n}$$

$$v_f = n \times f_z \times Z \quad f_z = \frac{f}{Z} = \frac{v_f}{n \times Z}$$

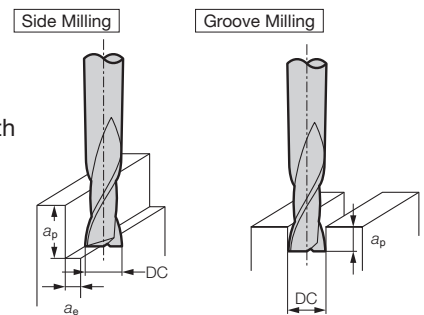

(Ballnose Endmill)

● Calculating notch width (D₁)

$$D_1 = 2 \times \sqrt{2 \times RE \times a_p - a_p^2}$$

● Cutting speed and feed rate (per revolution and per tooth) are calculated using the same formula as the square endmill.

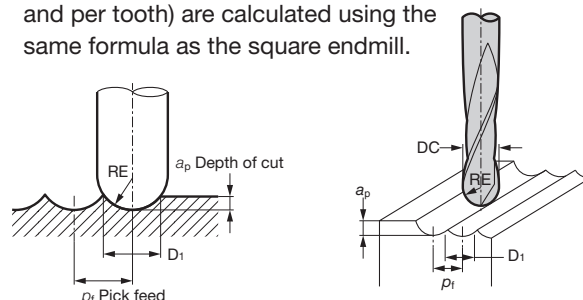

- v_c : Cutting speed (m/min)
- π : ≈ 3.14
- DC : Endmill diameter (mm)
- n : Spindle speed (min⁻¹)
- v_f : Feed rate (mm/min)
- f : Feed rate per revolution (mm/rev)
- f_z : Feed rate per tooth (mm/t)
- Z : Number of teeth
- a_p : Depth of cut in axial direction (mm)
- a_e : Depth of cut in radial direction (mm)
- RE : Ballnose radius

The Basics of Endmilling, Endmilling Edition

Up-cut and Down-cut

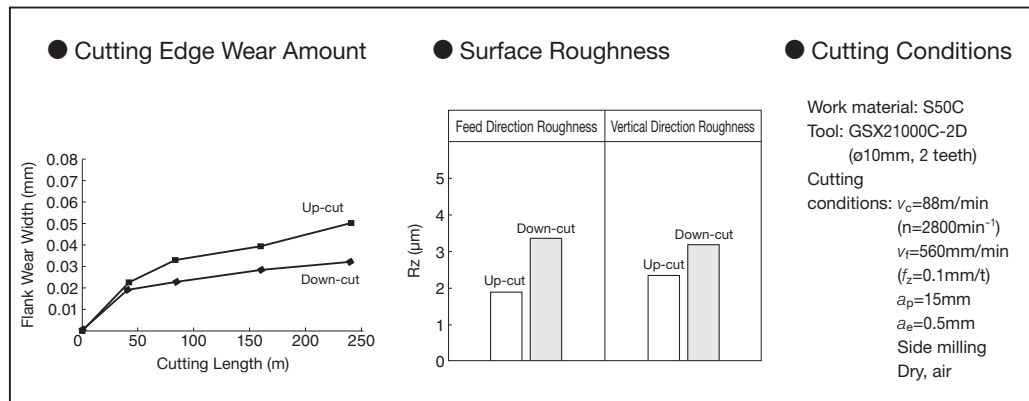
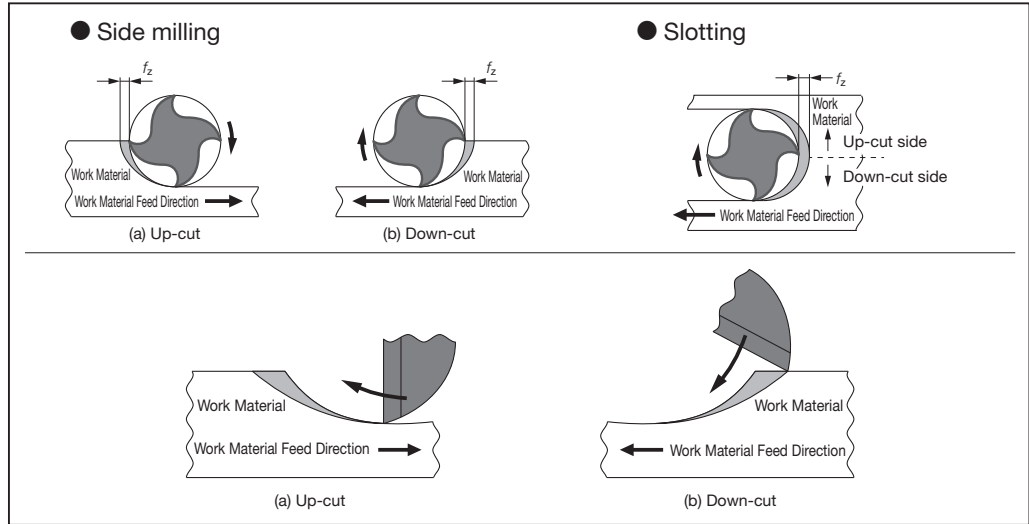

Relation between cutting conditions and deflection

Endmill specifications			Side milling				Grooving			
			Work Material: Pre-hardened steel (40HRC) Cutting conditions: $v_c=25\text{m/min}$ $a_p=12\text{mm}$ $a_e=0.8\text{mm}$		Work Material: Pre-hardened steel (40HRC) Cutting conditions: $v_c=25\text{m/min}$ $a_p=8\text{mm}$ $a_e=8\text{mm}$					
Cat. No.	Number of Teeth	Helix Angle	Feed Rate		Feed Rate		Feed Rate		Feed Rate	
			0.16mm/rev	0.11mm/rev	0.05mm/rev	0.03mm/rev	0.05mm/rev	0.03mm/rev		
			Style		Style		Style		Style	
			Up-cut	Down-cut	Up-cut	Down-cut	Up-cut	Down-cut	Up-cut	Down-cut
GSX20800S-2D	2	30°								
GSX40800S-2D	4	30°								
Results			<ul style="list-style-type: none"> The tool tip tends to back off with the down-cut. The 4-flute type offers more rigidity and less backing off. 				<ul style="list-style-type: none"> The side of the slot tends to cut into the up-cut side toward the bottom of the slot. The 4-flute type offers higher rigidity and less deflection. 			

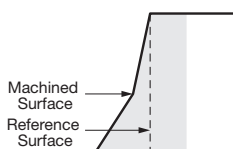

■ Troubleshooting for Endmilling

Failure		Cause		Countermeasures
Cutting Edge Failure	Excessive Wear	· Cutting Conditions	· Cutting speed is too fast · Feed rate is too large	· Decrease cutting speed and feed rate
		· Tool Shape	· The flank relief angle is too small	· Change to an appropriate flank relief angle
		· Tool Material	· Insufficient wear resistance	· Select a more wear-resistant substrate · Use a coated tool
	Chipping	· Cutting Conditions	· Feed rate is too large	· Decrease cutting speed
			· Depth of cut is too large	· Reduce depth of cut
			· Tool overhang is too long	· Adjust tool overhang to the correct length
	Fracture	· Machine Area	· Workpiece clamping is too weak	· Clamp the workpiece firmly
			· Tool mounting is unstable	· Make sure the tool is seated in the chuck properly
			· Fracture	· Feed rate is too large
Others	Deflection in wall surface	· Cutting Conditions	· Depth of cut is too large	· Reduce depth of cut
			· Tool overhang is too long	· Adjust tool overhang to the correct length
			· Cutting on the down-cut	· Change direction to up-cut
			· Fracture	· Depth of cut is too large
		· Tool Shape	· Tool overhang is too long	· Reduce tool overhang as much as possible
	· Cutting edge is too long		· Select a tool with a shorter cutting edge	
	Unsatisfactory Machined Surface Finish	· Tool Shape	· Web thickness is too small	· Change to more appropriate web thickness
			· Fracture	· Feed rate is too large
		· Cutting Conditions	· Chip biting	· Use air blow · Use an insert with a larger relief pocket
			· Chattering	· Cutting speed is too fast
	Chip blockage	· Cutting Conditions	· Cutting on the up-cut	· Change direction to down-cut
			· Tool overhang is too long	· Adjust tool overhang to the correct length
			· Rake angle is too large	· Use a tool with an appropriate rake angle
		· Machine Area	· Workpiece clamping is too weak	· Clamp the workpiece firmly
			· Tool mounting is unstable	· Make sure the tool is seated in the chuck properly
· Cutting Conditions	· Feed rate is too large	· Decrease cutting speed		
	· Depth of cut is too large	· Reduce depth of cut		
· Tool Shape	· Too many teeth	· Reduce number of teeth		
	· Chip biting	· Use air blow		

Basics of Drilling, Drilling Edition

Parts of drill

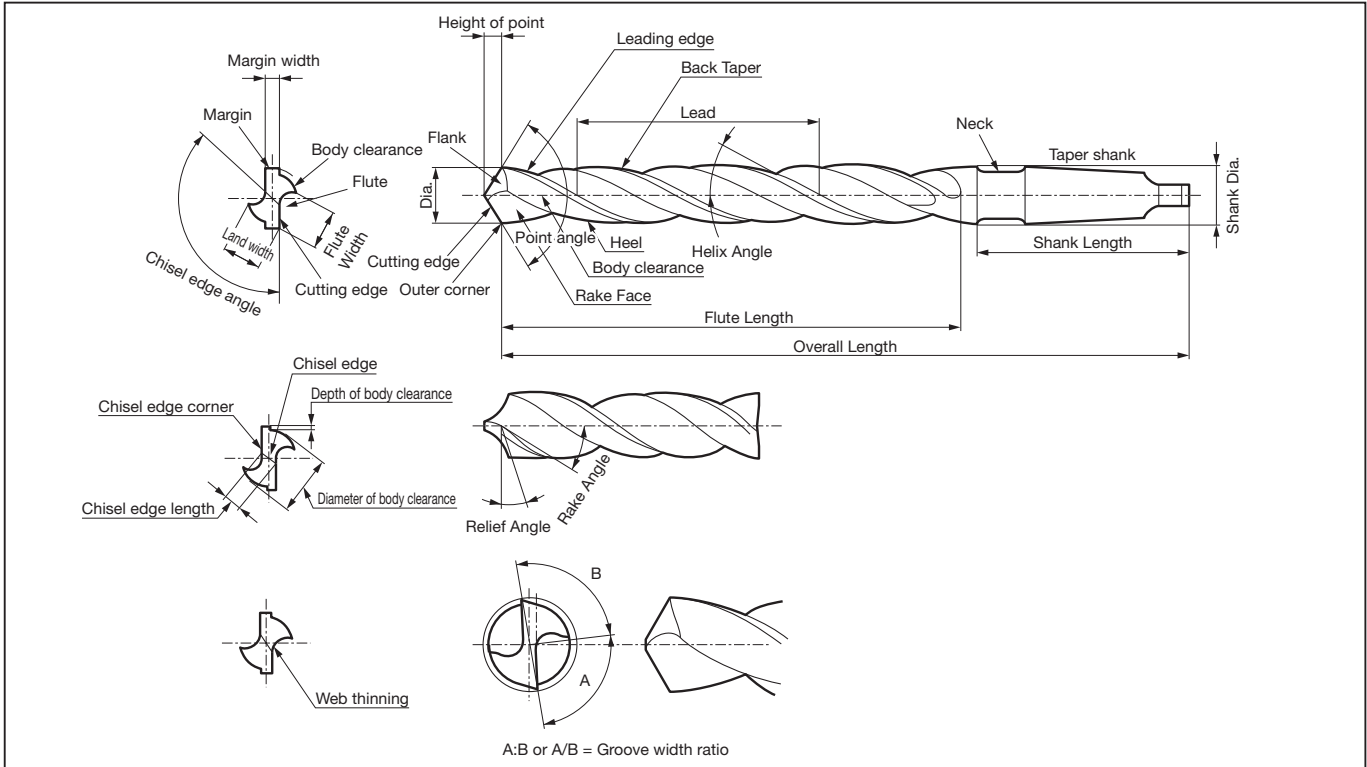

Point angle and force

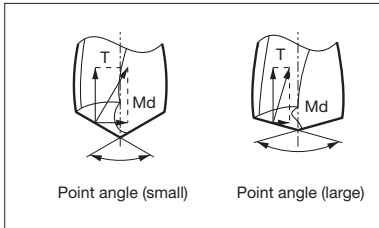

When point angle is large, thrust increases but torque decreases.

Point angle and burr

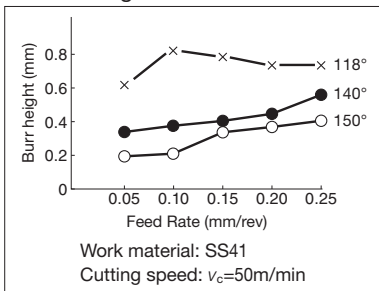

When point angle is large, burr height becomes low.

Minimum requirement relief angle for drilling

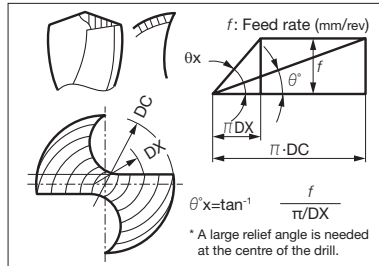

Relation between edge treatment and cutting force

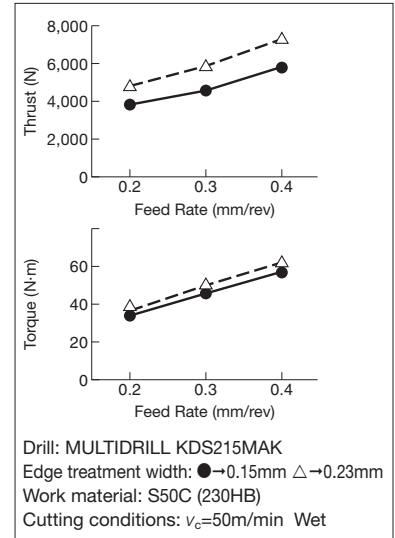

Effects of web thinning

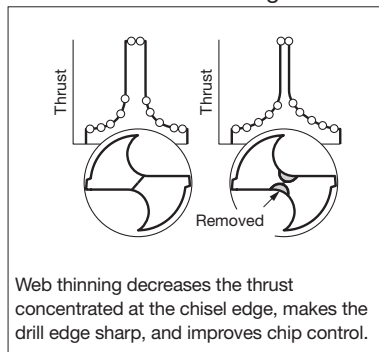

Chisel width decreased by thinning

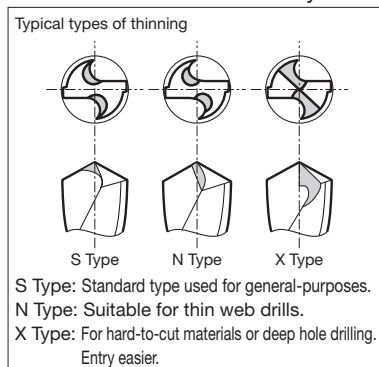

Basics of Drilling, Drilling Edition

■ Reference of power requirement and thrust

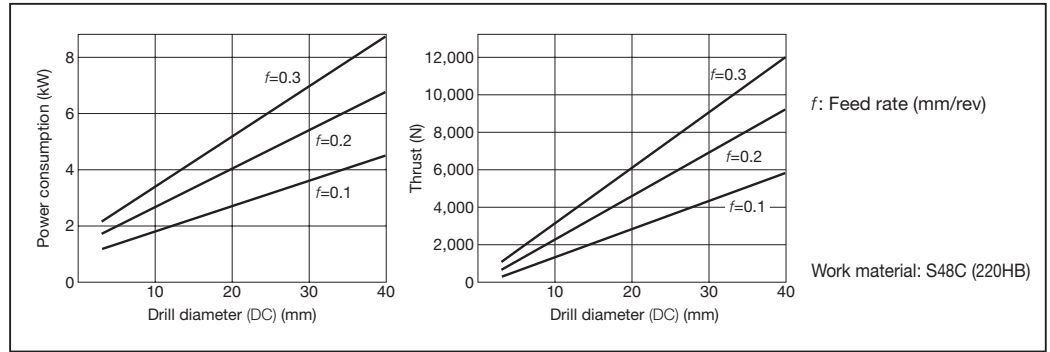

■ Cutting condition selection

- Control cutting force
For low-rigidity machines

The following table shows the relation between edge treatment width and cutting force. If the cutting force is too great and causes issues, take measures such as reducing the feed rate or reducing the cutting edge treatment of the drill.

Cutting Conditions		Edge treatment width			
		0.15mm		0.05mm	
v_c (m/min)	f (mm/rev)	Torque (N/m)	Thrust (N)	Torque (N/m)	Thrust (N)
40	0.38	12.8	2,820	12.0	2,520
50	0.30	10.8	2,520	9.4	1,920
60	0.25	9.2	2,320	7.6	1,640
60	0.15	6.4	1,640	5.2	1,100

Drill Diameter: $\phi 10$ mm
Work material: S50C (230HB)

- High speed machining recommendation

If the machine has enough power and sufficient rigidity, reasonable tool life can be ensured even when adopting higher-efficiency machining. However, sufficient coolant must be supplied.

Wear example

The figure shows two photographs of drill bit wear. The left image is labeled $v_c=60$ m/min and shows a drill bit with significant wear on the flank and rake face. The right image is labeled $v_c=120$ m/min and shows a drill bit with less wear. Labels 'Margin', 'Flank', and 'Rake Face' are present with arrows pointing to the respective areas.

Work material : S50C (230HB)
Cutting conditions: $f = 0.3$ mm/rev
H=50mm
Tool life : 600 holes (Cutting length: 30m)

■ Explanation of Margins (Difference between single and double margins)

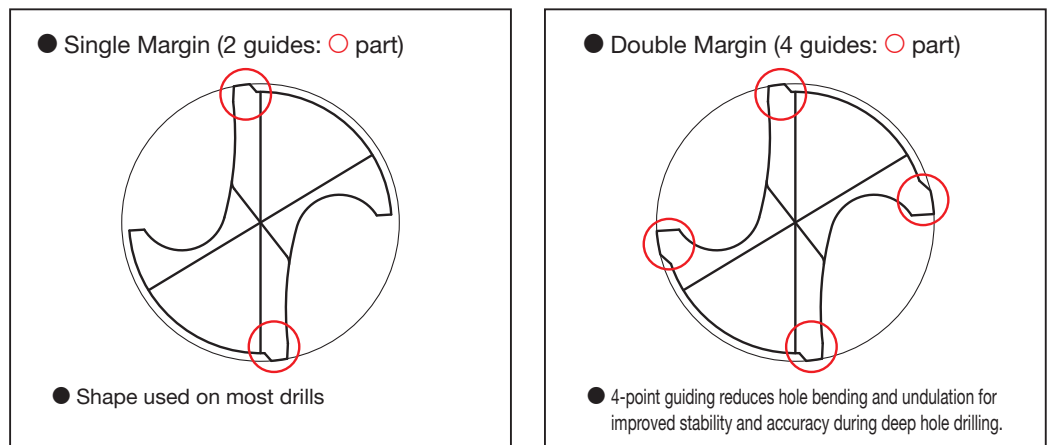

Runout accuracy

For the runout accuracy of web-thinned drills, the runout after thinning (A) is important in addition to the difference in lip height (B).

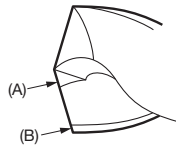

(A): Runout accuracy of thinning point
(B): The difference of the lip height

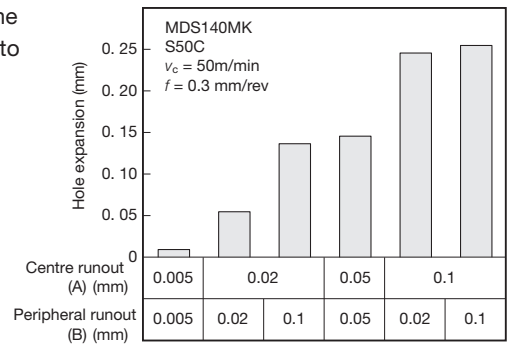

Drill mounting peripheral runout accuracy

When the tool rotates

The peripheral runout accuracy of the drill mounted on the spindle should be controlled within 0.03mm. If the runout exceeds the limit, the drilled hole will also become large and an increase in the horizontal cutting force, which may result in drill breakage.

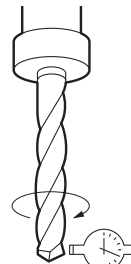

Runout: Within 0.03mm

Peripheral runout (mm)	Hole expansion		Cutting Force*	
	0	0.05 (mm)	0	10 (kg)
0.005	~0.01	~0.02	~0	~5
0.09	~0.05	~0.1	~10	~15

* Horizontal cutting force.

Drill: MDS120MK, work material: S50C (230HB)
Cutting Conditions: $v_c=50\text{m/min}$, $f=0.3\text{mm/rev}$, $H=38\text{mm}$
Water-soluble Coolant

When the work material rotates

The peripheral runout at the drill edge (A) and the concentricity at (B) should be controlled within 0.03mm.

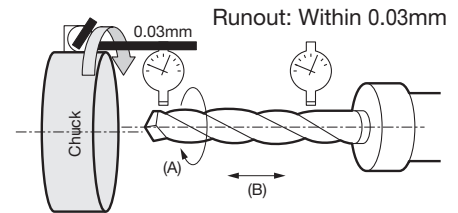

Runout: Within 0.03mm

Work material surface and drill performance

Work material with slanted or uneven surface

If the surface of the hole entrance or exit is slanted or uneven, decrease the feed rate to 1/3 to 1/2 of the recommended cutting conditions.

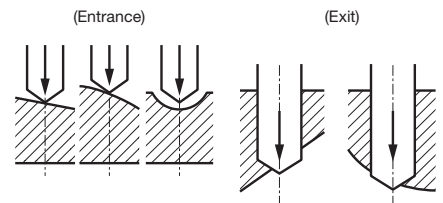

How to use a long drill

Problem

When using a long drill (e.g. XHGS Type), SMDH-D Type drill or SMDH-12D Type drill at high rotation speeds, the runout of the drill tip may cause a deviation of the entry point as shown on the right, bending the drill hole and resulting in drill breakage.

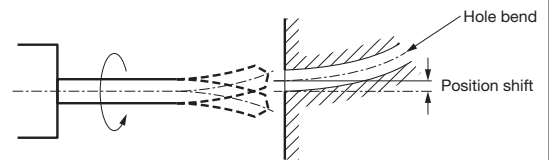

Remedies

Method 1

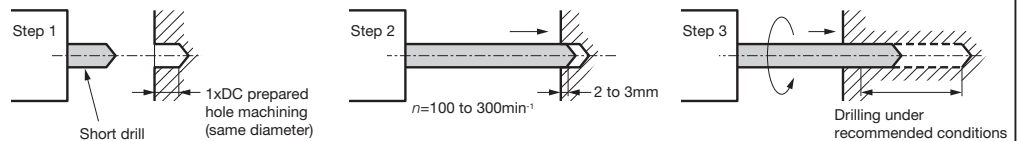

Method 2 *Low rotational speed minimises centrifugal forces and prevents the drill from bending.



■ Drill Retention

(1) Collet Selection and Maintenance

- Ensure proper chucking of drills to prevent vibration. Collet type chucks are recommended, as the grip is strong and can be used with ease.
(Drill chucks and keyless chucks are not suitable for MULTIDRILLS as they have a weaker grip force.)
- When replacing drills, regularly remove cutting chips inside the collet by cleaning the collet and the spindle with oil. Repair marks with an oilstone.

(2) Drill Mounting

- The peripheral runout of the drill mounted on the spindle must be within 0.03mm.
- Do not chuck on the drill flute.
(If the drill flute is inside the holder, chip evacuation will be obstructed, causing damage to the drill.)

Collet Chuck Drill Chuck

Collet
If there are marks, repair with an oilstone or change to a new one.

Peripheral runout within 0.03mm. Do not grip on the drill flute.

■ Using Cutting Oil

(1) Choosing Cutting Oil

- If the cutting speed is more than 40m/min, cutting oil (JISW1 type 2) is recommended as its cooling effects and chip control capacity are good, and it is highly soluble.
- For optimum tool life at cutting speeds of less than 40m/min, sulfo-chlorinated oil (JISA1 type 1) is recommended as it has a lubricating effect and is non-water soluble. * Insoluble cutting oil may be flammable. To prevent fire, a substantial amount of oil should be used to cool the component so that smoke and heat will not be generated.

(2) Supply of Coolant

- External Coolant Supply
There must be a sufficient external supply of coolant at the hole position. Coolant pressure 0.3 to 0.5MPa, coolant volume 3 to 10 l/min is a guideline.
- Internal Coolant Supply
For holes ø4 or smaller, the oil pressure must be at least 1.5MPa to ensure a sufficient supply of coolant. For ø6 and above, if L/D is < 3, the pressures should be at 0.5 to 1.0MPa. If L/D is > 3, a hydraulic pressure of at least 1 to 2MPa is recommended.

- External Coolant Supply
- Vertical drilling

Use high pressure at entrance Easy to use

- Horizontal drilling

Use high pressure at entrance

- Internal Coolant Supply
- Coolant supply equipment
- Internal supply from machine

■ Calculation of Power Consumption and Thrust

- Calculating cutting speed

$$v_c = \frac{\pi \times DC \times n}{1,000}$$

$$n = \frac{1,000 \times v_c}{\pi \times DC}$$

- Calculating feed rate per revolution and per tooth

$$v_f = n \times f$$

$$f = \frac{v_f}{n}$$

v_c : cutting speed (m/min)
 π : ≈ 3.14
 DC : Drill diameter (mm)
 n : Rotation speed (min^{-1})
 v_f : Feed rate (mm/min)
 f : Feed rate per revolution (mm/rev)
 H : Drilling depth (mm)
 T : Cutting time (min)
 HB : Work material Brinell hardness

- Calculation of Cutting Time

$$T = \frac{H}{v_f}$$

- Calculation of Power Consumption and Thrust <Experimental>

Power consumption (kW) = $HB \times DC^{0.68} \times v_c^{1.27} \times f^{0.59} / 36,000$

Thrust (N) = $0.24 \times HB \times DC^{0.95} \times f^{0.61} \times 9.8$

* When designing the machine, an allowance of 1.6 x power consumption and 1.4 x thrust should be given.

■ Clamping of the Workpiece

High thrust forces occur during high-efficiency drilling. Therefore, the workpiece must be supported to prevent fractures caused by deformation. Large torques and horizontal cutting forces also occur. Therefore, the workpiece must be clamped firmly enough to withstand them.

Especially large drills

Deformation → chipping Support needed

■ Drill Regrinding

- When to regrind
When one or two feed marks (lines) appear on the margin, when corner wear reaches the margin width or when small chipping occurs, it indicates that the drill needs to be sent for regrinding. Regrind promptly.
- How and where to regrind
We recommend regrinding and recoating. Regrinding alone is fine, but if the work material is steel, recoating is recommended to prevent shortening of tool life. Note: Ask us or an approved vendor to recoat with our proprietary coating.
- Regrinding on your own
Customers regrinding their own drills can obtain MULTIDRILL Regrinding Instructions from us directly or their vendor.

- Tool life determinant

1 to 2 feed marks

○ Appropriate Tool Life

Excessive marks

× Over-used

Troubleshooting for Drilling, Drilling Edition

■ Troubleshooting for Drilling

Failure		Cause	Basic Remedies	Countermeasure Examples	
Drill Failure	Excessive Wear on Rake Face	· Inappropriate cutting conditions	· Use higher cutting speeds · Increase feed rate	· Refer to the upper limit of the recommended cutting conditions listed in this catalogue · Refer to the upper limit of the recommended cutting conditions listed in this catalogue	
		· Unsuitable coolant	· Reduce pressure if using internal coolant · Use coolant with more lubricity	· 1.5MPa or less (external coolant supply can be used at hole depths (L/D) of 2 or less) · Use JIS A1 grade No. 1 or its equivalent	
	Chisel Point Breakage	· Off-centre starts	· Reduce feed rate at entry point · Pre-machining of flat surface for entry	· $f=0.08$ to 0.12mm/rev · Drill flat base with Flat MULTIDRILL	
		· Equipment, work materials, etc. lack rigidity	· Change cutting conditions to reduce resistance · Improve clamp strength of work material	· Increase v_c to decrease f (reduce thrust)	
		· Cutting edge is too weak	· Increase size of chisel width · Increase amount of honing on cutting edge	· Use a chisel with a width of 0.1 to 0.2mm · Increase the width of the thinning area at the centre by 1.5 times	
	Breakage on Peripheral Cutting Edge	· Inappropriate cutting conditions	· Decrease the cutting speed · Reduce feed rate	· Refer to the lower limit of the recommended cutting conditions listed in this catalogue · Refer to the lower limit of the recommended cutting conditions listed in this catalogue	
		· Unsuitable coolant	· Use coolant with more lubricity	· Use JIS A1 grade No. 1 or its equivalent	
		· Equipment, work materials, etc. lack rigidity	· Improve clamp strength of work material		
		· Cutting edge is too weak	· Increase amount of honing on cutting edge · Reduce the front relief angle	· Increase the width of the outer cutting edge by 1.5 times · Reduce the front relief angle by 2 to 3°	
		· Entry from peripheral cutting edge	· Increase margin width (W margin specification)	· Increase the margin width by 2 to 3 times	
	Margin Wear	· Interruption during drill engagement	· Reduce feed rate · Increase amount of honing on cutting edge · Reduce the front relief angle	· Refer to the lower limit of the recommended cutting conditions listed in this catalogue · Increase the width of the outer cutting edge by 1.5 times · Reduce the front relief angle by 2 to 3°	
		· Inappropriate cutting conditions	· Decrease the cutting speed	· Refer to the lower limit of the recommended cutting conditions listed in this catalogue	
		· Unsuitable coolant	· Use coolant with more lubricity · Use more coolant	· Use JIS A1 grade No. 1 or its equivalent · If using external coolant, switch to internal coolant	
		· Remaining margin wear	· Schedule for earlier regrind and ensure back taper	· If margin damage occurs, regrind to 1mm or less	
	Drill Breakage	· Improper tool design	· Increase amount of back taper · Reduce margin width	· Make back taper 0.5/100 · Reduce the margin width to around 2/3	
		· Chip blockage	· Use the optimal cutting conditions and tools · Use more coolant	· Refer to recommended cutting conditions listed in this catalogue · If using external coolant, switch to internal coolant	
		· Collet clamp too weak	· Use a collet with strong grip force	· If the collet chuck is damaged, replace it · Change the collet holder to the next size up	
	Unsatisfactory Hole Accuracy	Oversized Holes	· Equipment, work materials, etc. lack rigidity	· Improve clamp strength of work material	
· Off-centre starts			· Reduce feed rate at entry point · Decrease the cutting speed · Pre-machining of flat surface for entry	· $f=0.08$ to 0.12mm/rev · Refer to the lower limit of the recommended cutting conditions listed in this catalogue · Flat machining with endmill	
· Drill lacks rigidity			· Use the optimal drill type for the hole depth · Improve overall drill rigidity	· Refer to this catalogue · Large web, small groove width	
· Drill has runout			· Improve drill mounting precision · Improve drill retention rigidity	· If the collet chuck is damaged, replace it · Change the collet holder to the next size up	
Poor Surface Roughness		· Inappropriate cutting conditions	· Increase cutting speed · Reduce feed rate	· Refer to the upper limit of the recommended cutting conditions listed in this catalogue · Refer to the lower limit of the recommended cutting conditions listed in this catalogue	
		· Unsuitable coolant	· Use coolant with more lubricity	· Use JIS A1 grade No. 1 or its equivalent	
Holes are not straight		· Off-centre starts	· Increase feed rate	· Refer to the upper limit of the recommended cutting conditions listed in this catalogue	
		· Drill is not mounted properly	· Improve drill mounting precision · Improve drill retention rigidity	· If the collet chuck is damaged, replace it · Change the collet holder to the next size up	
		· Equipment, work materials, etc. lack rigidity	· Improve clamp strength of work material · Select a double margin tool	· Refer to this catalogue	
Unsatisfactory Chip Control		Chips clog	· Inappropriate cutting conditions	· Increase cutting speeds · Increase feed rate	· Refer to the upper limit of the recommended cutting conditions listed in this catalogue · Refer to the upper limit of the recommended cutting conditions listed in this catalogue
			· Poor chip evacuation	· Increase volume if using internal coolant	
		Long Stringy Chips	· Inappropriate cutting conditions	· Increase feed rate · Increase cutting speeds	· Refer to the upper limit of the recommended cutting conditions listed in this catalogue · Refer to the upper limit of the recommended cutting conditions listed in this catalogue
	· Strong cooling effect		· Reduce pressure if using internal coolant	· The pressure should be 1.5 MPa or less if using internal coolant	
· Dull cutting edge	· Reduce amount of edge honing	· Reduce the width to around 2/3			

Hardened Steel Machining with SUMIBORON, SUMIBORON Edition

Recommended Zones for SUMIBORON by Workpiece Hardness and Shape

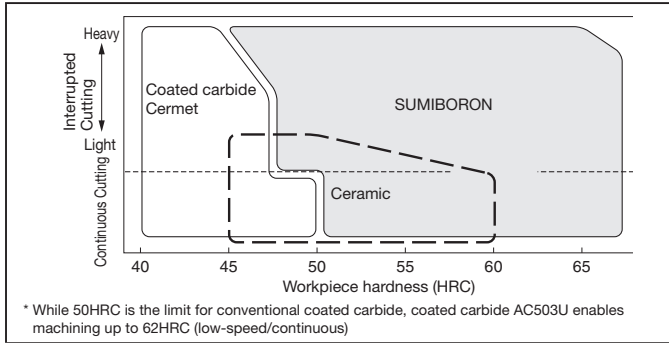

Cutting speed recommendations for each work material

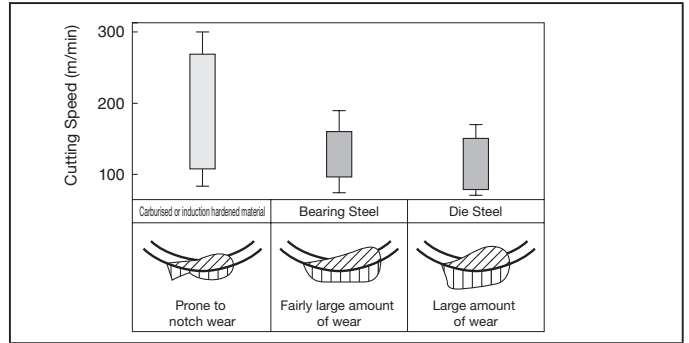

Influence of coolant on tool life

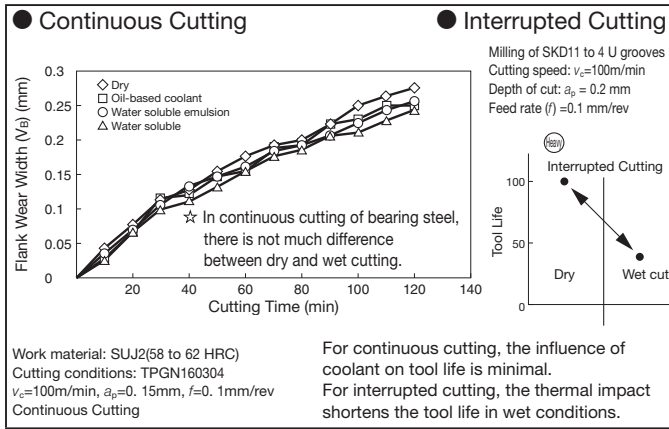

Relation between work material hardness and cutting force

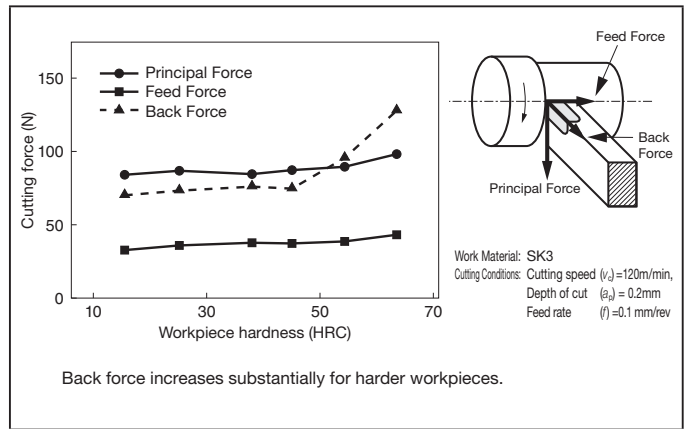

Relation between flank wear and cutting force

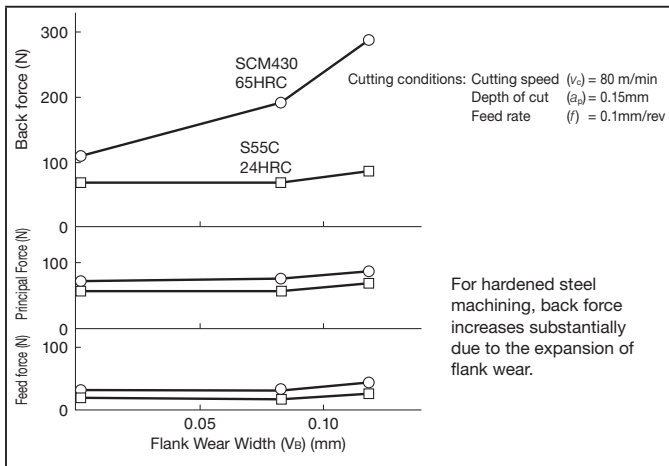

Influence of work material hardness on cutting force and accuracy

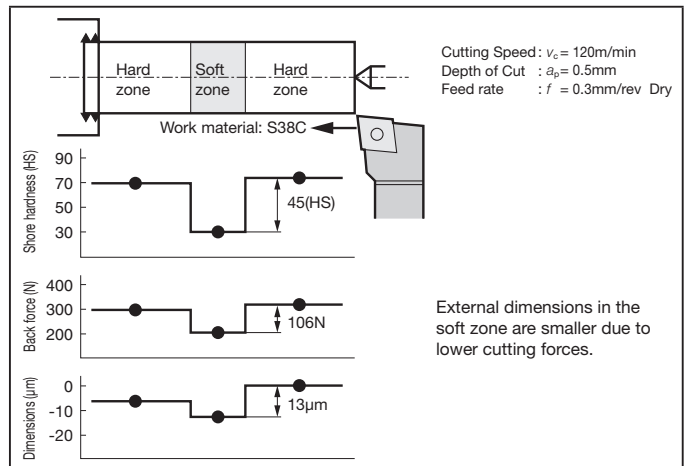

Relation between cutting speed and surface roughness

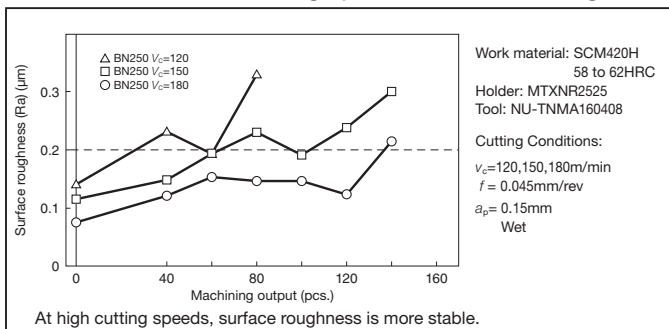

Improvement of surface roughness by altering the feed rate

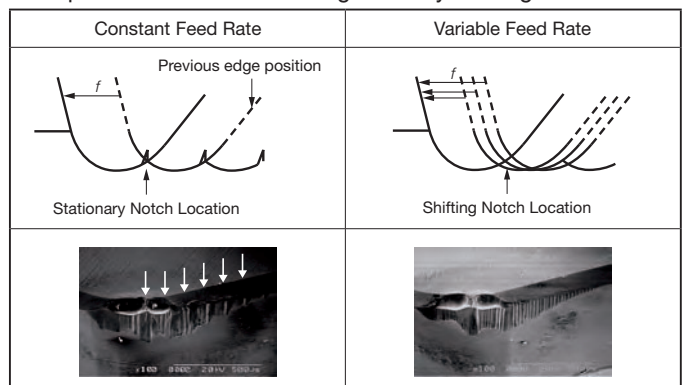

Advantages of using SUMIBORON for cast iron machining

High-speed Machining

● Gray Cast Iron

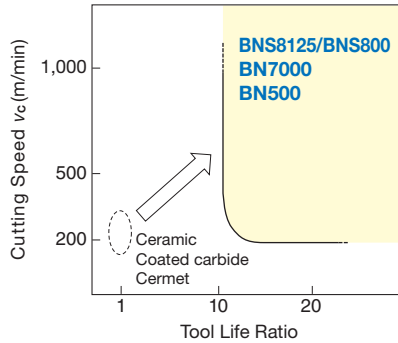

High-speed Machining

● Ductile Cast Iron

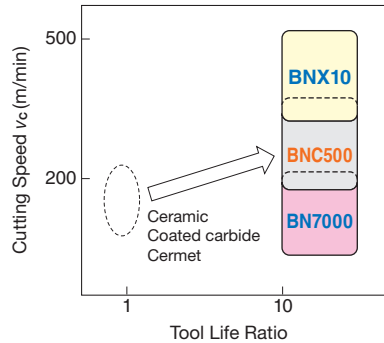

High-precision Machining

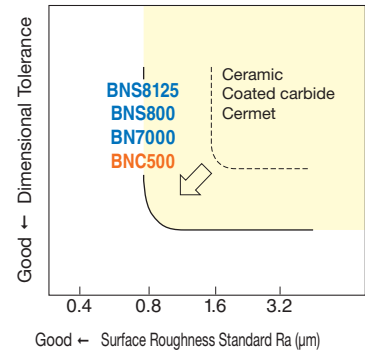

Turning

● Cast iron structure and wear shape examples

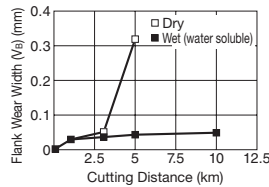
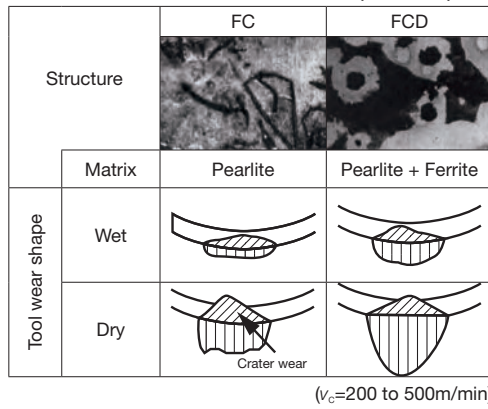

Work material : Continuous cutting with FC250
 Tool material : BN500
 Tool Shape : SNGN120408
 Cutting Conditions : $v_c=450$ m/min
 $a_p=0.25$ mm
 $f=0.15$ mm/rev
 Dry & Wet (water soluble)

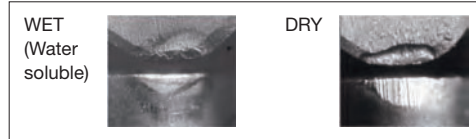
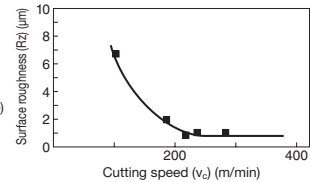

Machine : N/C lathe
 Work Material : FC250 200HB
 Holder : MTJNP2525
 Tool Grade : BN500
 Tool Shape : TNMA160408
 Cutting Conditions : $v_c=110$ to 280 m/min
 $f=0.1$ mm/rev
 $a_p=0.1$ mm
 Wet

For turning cast iron with SUMIBORON, cutting speeds (v_c) should be 200m/min and above. Wet cutting is recommended.

Milling

BN Finish Mill EASY (for high-speed finishing of cast iron)



- Enables cutting with v_c of 2,000m/min
- Surface finish roughness 3.2Rz (1.0Ra)
- Economical insert reduces running costs.
- Unit style enables easy runout adjustment.
- Employs safe, anti-centrifugal-force construction for high-speed conditions.

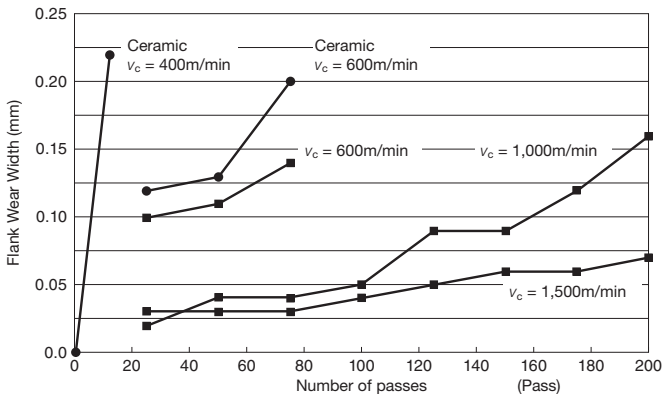

· Work material: Gray cast iron (FC250)
 · Cutting conditions: $a_p=0.5$ mm, $f_z=0.1$ mm/t Dry
 · Tool grade: BN7000

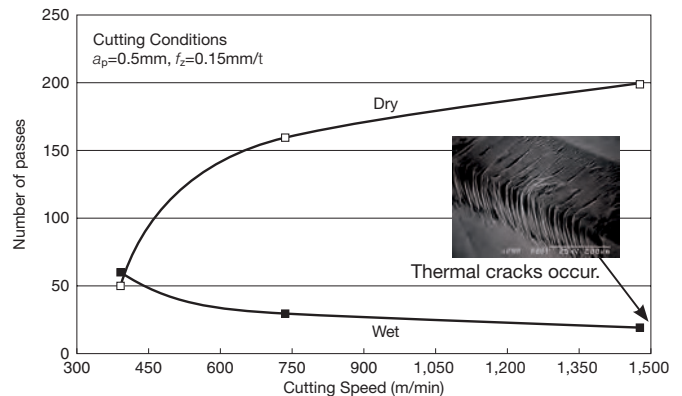

Dry cutting is recommended for high speed milling of cast iron with SUMIBORON.

Machining Exotic Alloys with SUMIBORON, SUMIBORON Edition

■ Sintered Alloy

● SUMIBORON ■ Cemented Carbide ○ Cermet

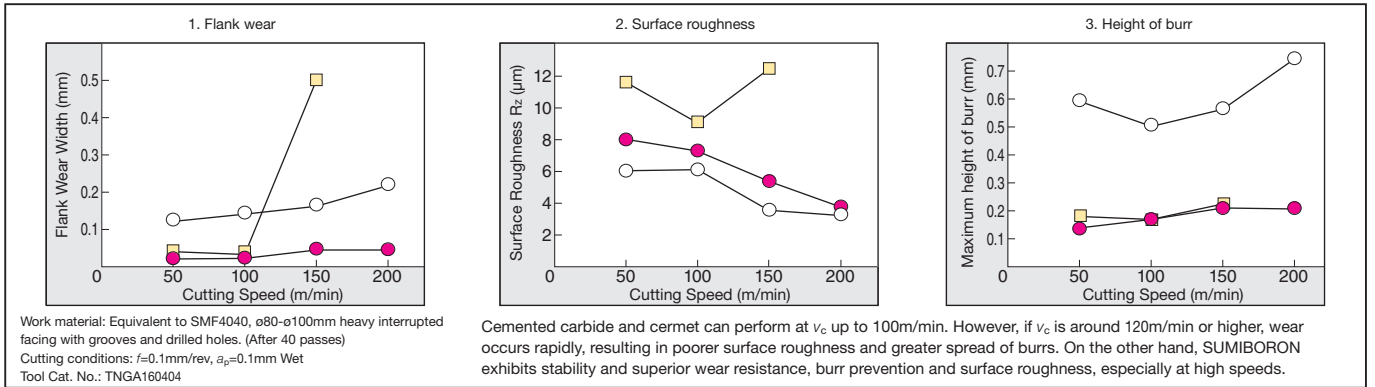

■ Heat-Resistant Alloy

● Nickel based alloy

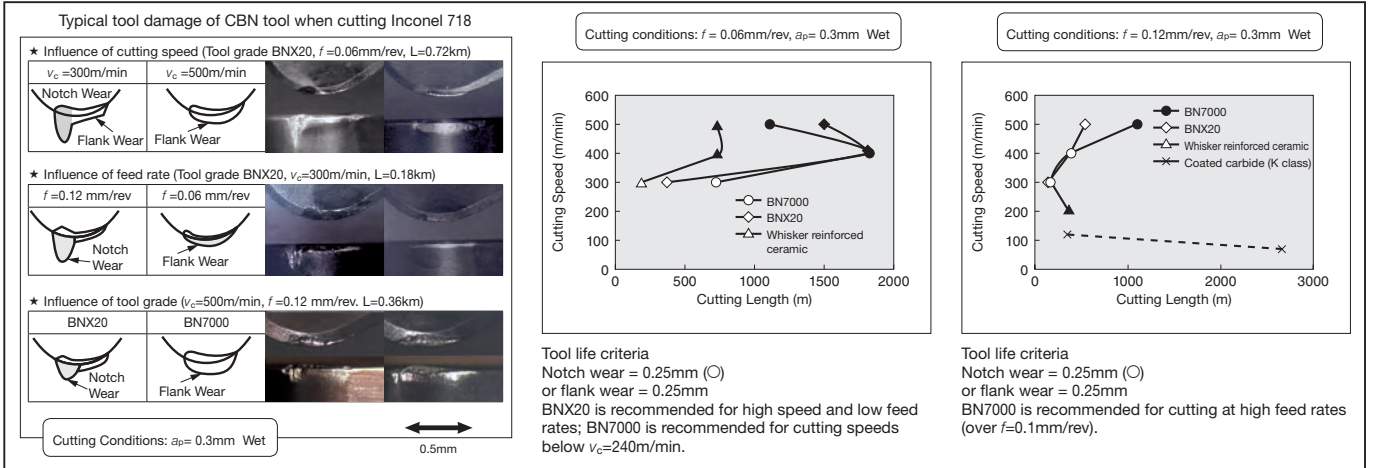

■ Cutting Performance (Machining Titanium Alloy)

● Wear Resistance

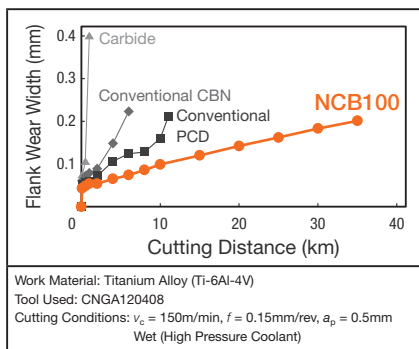

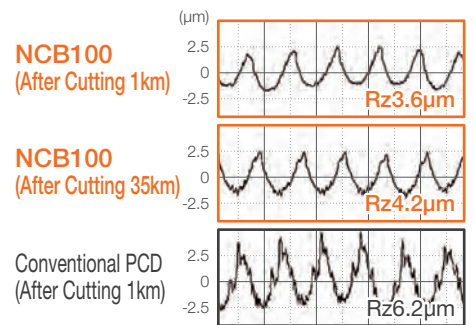
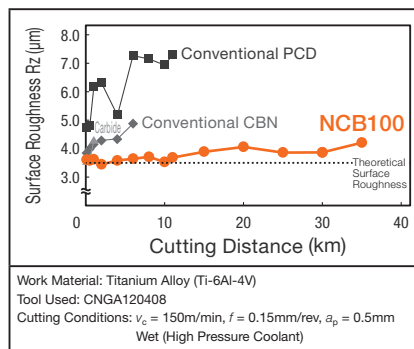

● Machined Surface Roughness

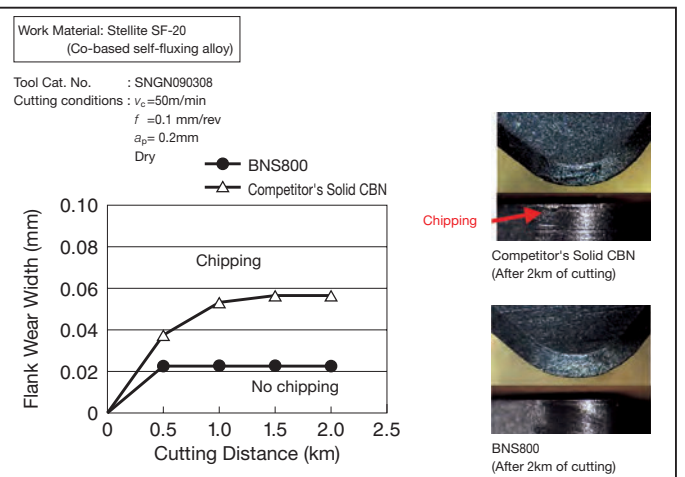
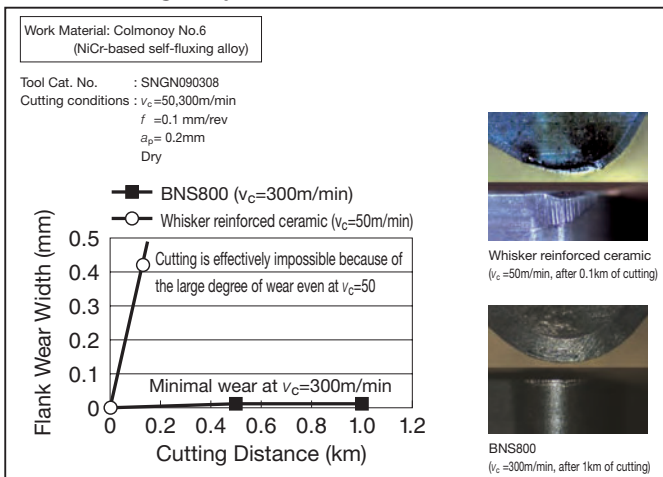

■ Hard facing alloys

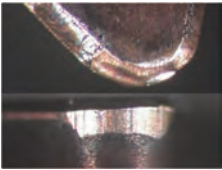
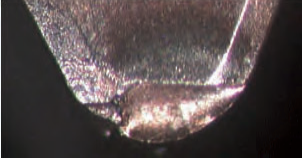
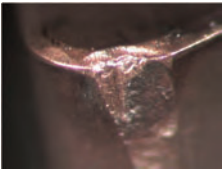
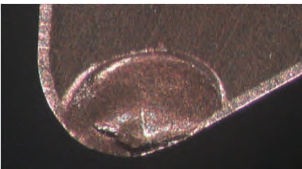
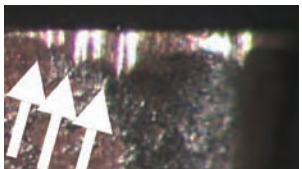
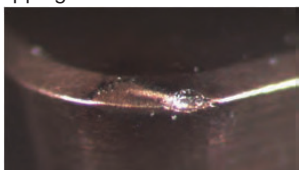

Insert Failure	Cause	Countermeasures
Flank Wear 	<ul style="list-style-type: none"> Grade lacks wear resistance 	<ul style="list-style-type: none"> Select a more wear-resistant grade (e.g. BNC2115, BNC2010, BN1000 or BN2000)
	<ul style="list-style-type: none"> Cutting speed is too fast 	<ul style="list-style-type: none"> Reduce the cutting speed to $v_c=200\text{m/min}$ or less (higher feed rate also reduces tool-to-work contact time) Use an insert with a larger relief angle
Crater wear 	<ul style="list-style-type: none"> Grade lacks crater wear resistance 	<ul style="list-style-type: none"> Select a higher-efficiency grade (e.g. BNC2115, BNC2010, BNX25 or BNX20)
Breakage at Bottom of Crater 	<ul style="list-style-type: none"> Cutting speed is too fast 	<ul style="list-style-type: none"> Reduce the cutting speed to $v_c=200\text{m/min}$ or less and increase the feed rate (low speed, high feed) (higher feed rate alone also reduces tool-to-work contact time)
Flaking 	<ul style="list-style-type: none"> Grade lacks toughness 	<ul style="list-style-type: none"> Select a tougher grade (e.g. BNC2125, BNC2020 or BN2000)
	<ul style="list-style-type: none"> Back force is too high 	<ul style="list-style-type: none"> Select an insert with a stronger cutting edge (increase negative land angle and perform honing) If the grade is tough enough, improve the cutting edge sharpness
Notch Wear 	<ul style="list-style-type: none"> High stress at boundary 	<ul style="list-style-type: none"> Change to a grade with a higher notch wear resistance (e.g. BNC2115, BNC2010 or BN2000) Increase cutting speed (150 m/min or more) Change to the Variable Feed Rate method, which alters the feed rate in fixed output intervals Increase negative land angle and perform honing
Chipping at Forward Notch Position 	<ul style="list-style-type: none"> Impact to front cutting edge is too large or occurs constantly 	<ul style="list-style-type: none"> Change to a micro-grained grade with a higher fracture resistance (e.g. BNC300 and BN350) Increase the feed rate (higher feed rates are recommended to reduce chipping) Select an insert with a stronger cutting edge (increase negative land angle and perform honing)
Chipping at Side Notch Position 	<ul style="list-style-type: none"> Impact to side cutting edge is too large or occurs constantly 	<ul style="list-style-type: none"> Change to a grade with a higher fracture resistance (e.g. BN350 or BNC300) Reduce feed rate Use an insert with a larger side cutting angle Use an insert with a larger corner radius Select an insert with a stronger cutting edge (increase negative land angle and perform honing)
Thermal Crack 	<ul style="list-style-type: none"> Thermal shock is too severe 	<ul style="list-style-type: none"> Completely dry conditions are recommended Select a grade with better thermal conductivity Reduce cutting speed, feed rate, and depth of cut to decrease the machining load

Reference: SI Unit Conversion List

■ Basic SI units

● Quantity as a reference of SI

Quantity	Material	Symbol
Length	Metre	m
Mass	Kilogram	kg
Time	Second	s
Current	Ampere	A
Temperature	Kelvin	K
Quantity of substance	Mol	mol
Luminous intensity	Candela	cd

● Basic unit provided with unique name and symbol (extracted)

Quantity	Material	Symbol
Frequency	Hertz	Hz
Force	Newton	N
Pressure and stress	Pascal	Pa
Energy, work, and heat quantity	Joule	J
Power and efficiency	Watt	W
Voltage	Bolt	V
Electrical Resistance	Ohm	Ω

■ SI prefixes

● Prefix showing integral powers of 10 combined with SI units

Coefficient	Material	Symbol	Coefficient	Material	Symbol	Coefficient	Material	Symbol
10 ²⁴	Yotta	Y	10 ³	Kilo	k	10 ⁻⁹	Nano	n
10 ²¹	Zeta	Z	10 ²	Hecto	h	10 ⁻¹²	Pico	p
10 ¹⁸	Exa	E	10 ¹	Deca	da	10 ⁻¹⁵	Femto	f
10 ¹⁵	Peta	P	10 ⁻¹	Deci	d	10 ⁻¹⁸	Atto	a
10 ¹²	Tera	T	10 ⁻²	Centi	c	10 ⁻²¹	Zepto	z
10 ⁹	Giga	G	10 ⁻³	Milli	m	10 ⁻²⁴	Yocto	y
10 ⁶	Mega	M	10 ⁻⁴	Micro	μ			

■ Principal SI unit conversion list (portions are SI units)

● Force

N	kgf
1	1.01972 × 10 ⁻¹
9.80665	1

● Stress

Pa(N/m ²)	MPa(N/mm ²)	kgf/mm ²	kgf/cm ²	kgf/m ²
1	1 × 10 ⁻⁶	1.01972 × 10 ⁻⁷	1.01972 × 10 ⁻⁵	1.01972 × 10 ⁻¹
1 × 10 ⁶	1	1.01972 × 10 ⁻¹	1.01972 × 10	1.01972 × 10 ⁵
9.80665 × 10 ⁶	9.80665	1	1 × 10 ²	1 × 10 ⁶
9.80665 × 10 ⁴	9.80665 × 10 ⁻²	1 × 10 ⁻²	1	1 × 10 ⁴
9.80665	9.80665 × 10 ⁻⁶	1 × 10 ⁻⁶	1 × 10 ⁻⁴	1

● Pressure

1Pa = 1N/m², 1MPa = 1N/mm²

Pa(N/m ²)	kPa	MPa	GPa	bar	kgf/cm ²	mmHg or Torr
1	1 × 10 ⁻³	1 × 10 ⁻⁶	1 × 10 ⁻⁹	1 × 10 ⁻⁵	1.01972 × 10 ⁻⁵	7.50062 × 10 ⁻³
1 × 10 ³	1	1 × 10 ⁻³	1 × 10 ⁻⁶	1 × 10 ⁻²	1.01972 × 10 ⁻²	7.50062
1 × 10 ⁶	1 × 10 ³	1	1 × 10 ⁻³	1 × 10	1.01972 × 10	7.50062 × 10 ²
1 × 10 ⁹	1 × 10 ⁶	1 × 10 ³	1	1 × 10 ⁴	1.01972 × 10 ⁴	7.50062 × 10 ⁶
1 × 10 ⁵	1 × 10 ²	1 × 10 ⁻¹	1 × 10 ⁻⁴	1	1.01972	7.50062 × 10 ²
9.80665 × 10 ⁴	9.80665 × 10	9.80665 × 10 ⁻²	9.80665 × 10 ⁻⁵	9.80665 × 10 ⁻¹	1	7.35559 × 10 ²
1.33322 × 10 ²	1.33322 × 10 ⁻¹	1.33322 × 10 ⁻⁴	1.33322 × 10 ⁻⁷	1.33322 × 10 ⁻³	1.35951 × 10 ⁻³	1

● Work/Energy/Heat Quantity

J	kW·h	kgf·m	kcal
1	2.77778 × 10 ⁻⁷	1.01972 × 10 ⁻¹	2.38889 × 10 ⁻⁴
3.60000 × 10 ⁶	1	3.67098 × 10 ⁵	8.60000 × 10 ²
9.80665	2.72407 × 10 ⁻⁵	1	2.34270 × 10 ⁻³
4.18605 × 10 ³	1.16279 × 10 ⁻³	4.26858 × 10 ²	1

1Pa = 1N/m²

● Power (efficiency and motive energy) / Thermal flow 1J=1W/s, 1J=1N/m

W	kgf·m/s	PS	kcal/h
1	1.01972 × 10 ⁻¹	1.35962 × 10 ⁻³	8.60000 × 10 ⁻¹
1 × 10 ³	1.01972 × 10 ²	1.35962	8.60000 × 10 ²
9.80665	1	1.33333 × 10 ⁻²	8.43371
7.355 × 10 ²	7.5 × 10	1	6.32529 × 10 ²
1.16279	1.18572 × 10 ⁻¹	1.58095 × 10 ⁻³	1

1W = 1J/s, PS: Horsepower

● Specific heat

J/(kg·K)	1kcal (kg/°C) cal/(g·°C)
1	2.38889 × 10 ⁻⁴
4.18605 × 10 ³	1

● Thermal conductivity

W/(m·K)	kcal/(h·m·°C)
1	8.60000 × 10 ⁻¹
1.16279	1

● Spindle Speed

min ⁻¹	rpm
1	1

1min⁻¹=1rpm

References

Metals Symbols Chart (Excerpt)

Carbon Steel for Structural Use **P**

JIS	AISI/ASTM	DIN/EN	GB	BS	AFNOR	ГОСТ
S10C	1008 1010	C10E C10R 1.1122	08 10	040A10 045A10 045M10	XC10	08 10
S12C	1012	—	—	040A12	XC12	—
S15C	1015	C15E C15R 1.1132	15	055M15	—	15
S20C	1020	C22 CK22	20	070M20	—	20
S25C	1025	C25 C25E C25R C16D 1.0415	25	—	—	25
S30C	1030	C30 C30E C30R	30	080A30 080M30	—	30
S35C	1035	C35 C35E C35R 1.1172	35	080A35 080M36	—	35
S40C	1040 C40E	C40 C40E C40R 1.1186	40	060A40 080A40 080M40	—	40
S43C	1042 1043	—	—	080A42	XC42H1 XC42H2	40Г
S45C	1045 1045H	C45 C45E C45R 1.1191 1.1192	45	060A45 080M46	XC45	45
S50C	1049	C50 C50E C50R 1.1206	50	080M50	XC50	50
S53C	1050 1053	—	50Mn	080A52	XC54	—
S55C	1055	C55 C55E C55R 1.1203	55	070M55	XC55H1 XC55H2	55
S58C	1060	C60 C60E C60R	60	060A57 080A57	XC60	—
S60C	1059	C60E 1.1221	60 60Mn	—	—	60
S09CK	1010	C10E C10R	—	045A10 045M10	XC10	—
S15CK	1015	C15E C15R	—	—	XC12	—
S20CK	—	CK22	—	—	XC18	—

Cr Steel **P**

SCr415	5115	17Cr3 1.7016	15Cr	—	—	15X
SCr420	5120	—	20Cr	—	20MC5	20X
SCr430	5130 5132	34Cr4 34CrS4 1.7033	30Cr	530A30 530A32	32C4	30X
SCr435	5135	37Cr4 1.7034	35Cr	530A36	38C4	35X
SCr440	5140	41Cr4 41CrS4 1.7035	40Cr	530M40 530A40	42C4	40X
SCr445	5147	—	45Cr	—	—	45X

Nickel Chromium Steel **P**

SNC415	4720 4715	20NiCrMo2-2 10NiCr15-4 17CrNi16-6 1.5918 1.5805 1.6523	20CrNi 12CrNi2 15CrNi6K	—	—	20XH 12XH
SNC236	3140 4337	41CrCrMo7-3-2 34CrNiMo6	40CrNi 12CrNi2	—	—	40XH
SNC246	8645	—	45CrNi	—	—	45XH
SNC815	E3310	15NiCr13 1.5752	12CrNi3	—	—	12XH3A
SNC620	—	20NiCrMo13-4 1.6660	20CrNi3	—	—	20XH3A
SNC631	—	30NiCrMo16-6 1.6747	30CrNi3	—	—	30XH3A
SNC836	—	35NiCrMo16 1.6773	37CrNi3	—	—	—

Ni-Cr-Mo Steel **P**

SNCM220	8615 8617 8620 8622 4718	20NiCrMo2-2 20NiCrMoS2-2 17NiCrMo6 1.6566 1.6523	20CrNiMo 18CrMnNiMo 20NiCrMoK	805A20 805M20 805A22 805M22	20NCD 2	20XH2M 18XH2M
SNCM240	8637 8640	39NiCrMo3 1.6510	40CrNiMo	—	—	40XH2MA
SNCM415	—	—	—	—	—	—
SNCM420	4320	17NiCrMo6-4	20CrNi2Mo	—	—	20XH2M (20XHM)
SNCM439	4340	41NiCrMo7-3-2 1.6563	40CrNi2Mo	—	—	40XH2MA
SNCM447	4340	41NiCrMo7-3-2 1.6563	45CrNiMoV	—	—	—

Cr-Mo Steel **P**

SCM415	—	18CrMo4 1.7243	15CrMo	—	—	15XM
SCM420	—	20MoCr4 1.7321	20CrMo	708M20	—	20XM

Cr-Mo Steel (continued) **P**

JIS	AISI/ASTM	DIN/EN	GB	BS	AFNOR	ГОСТ
SCM421	4121	18CrMo4 22CrMoS35 1.7243	20CrMnMo	—	—	25XFM
SCM425	—	25CrMo 1.7218	25CrMo	—	—	—
SCM430	4130	—	30CrMo	708A30	30CD4	30XM
SCM435	4135 4137	34CrMo4 1.7220	35CrMo	708A37 709A37	34CD4 38CD4 35CD4	35XM
SCM440	4142 4140	42CrMo4 42CrMoS4 1.7225	42CrMo	708M40 708A40 708A42 709A42 709M40	42CD4	38XM
SCM445	4145 4150	50CrMo4 1.7228	50CrMo	708A47	—	—

Manganese Chromium Steel/Manganese Steel **P**

SMn420	1522 1524	18Mn5 1.0436	20Mn2	150M19 120M19	20M5	20Г
SMn433	1330	28Mn6 1.1170	30Mn2	—	—	30Г2
SMn438	1335 1541	—	35Mn2	150M36	40M6	35Г2
SMn443	1340 1345 1541	—	40Mn2 45Mn2	135M40 150M36	35M5	35Г2 45Г2
SMnC420	5120	20MnCr5 1.7147	20CrMn	—	—	18XГ
SMnC443	5140	41Cr4 1.7035	40CrMn	—	—	—

Carbon Tool Steel **P**

SK140 SK1	W2-13A W1-13	—	T13	—	Y ₂ 140	—
SK120 SK2	W1-11 1/2	C120U 1.1555	T12	BW1C	Y ₂ 120	y12
SK105 SK3	W1-10 W1-10 1/2	C105U 1.1545 C105W1	T11	BW1B	Y ₁ 105	—
SK95 SK4	W1-9 W1-9 1/2	C105U 1.1545	T10	BW1A	Y ₁ 90 Y ₁ 80	y10
SK85 SK5	W1-8C W1-8	C80W1	T8Mn	BW1A	—	y8Г
SK80	W1-8A	C80U 1.1525	T8	—	—	y8
SK70	1070	C70U 1.1520	T7	—	—	y7

High Speed Steel **P**

SKH2	T1	HS18-0-1 1.3355	W18Cr4V	BT1	Z80WCV 18-04-01	P18
SKH3	T4	S18-1-2-5	—	BT4	Z80WKC 18-05-04-01	—
SKH4	T5	—	—	BT5	Z80WKC 18-10-04-02	—
SKH10	T15	S12-1-4-5	W12Cr4V5Co5	BT15	Z160WKC 12-05-05-04	P12K5V5
SKH51	M2	S6-5-2 1.3339	W6Mo5Cr4V2	BM2	Z160WDCV 06-05-04-02	P6M5ø2
SKH52	M3-1	HS6-6-2 1.3350	W6Mo6Cr4V2	—	—	—
SKH53	M3-2	S6-5-3 HS6-5-3 1.3344	W6Mo5Cr4V3	—	Z160WDCV 06-05-04-03	P6M5ø3
SKH54	M4	—	W6Mo5Cr4V4	BM4	Z130WDCV 06-05-04-04	—
SKH55	M35 M41	S6-5-2-5 HS6-5-2-5 1.3243	W6Mo8Cr4V2Co5	BM35	Z190WDCV 06-05-05-04-02	P6M5K5
SKH56	M36	—	—	—	—	—
SKH57	M48	HS10-4-3-10 1.3207	W10Mo4C4V3Co10	—	Z130WKC 10-10-04-04-03	—
SKH58	M7	HS2-8-2 1.3348	W2Mo9Cr4V2	—	Z100DCWV 09-04-02-02	—
SKH59	M42	HS2-10-1-8 1.3247	W2Mo8Cr4VCo8	BM42	Z130DKCWV 09-08-04-02-01	P2M9K8ø

Alloy Tool Steel **P**

SKS11	F2	—	—	—	—	—
SKS2	—	105WCr6	—	—	105WC13	—
SKS51	L6	—	—	—	—	—
SKS41	—	—	4CrW2Si	—	—	4XB2C
SKS43	W2-9 1/2	—	—	BW2	Y ₁ 105V	—
SKS44	W2-8 1/2	—	—	—	—	—
SKS3	O1	95MnWCr5 1.2825	9CrWMn	—	—	9XBГ
SKS31	O7	105WCr6	CrWMn	—	105WC31	XBГ
SKD1	D3	X210Cr12 1.2080	Cr12	BD3	X200Cr12	X12
SKD4	—	—	30W4Cr2V	BH21	Z32WCV5	—
SKD5	H21	X30WCrV9-3 1.2581	3Cr2W8V	BH21	Z30WCV9	3X2B8ø
SKD6	H11	X37CrMoV5-1 1.2343	4Cr5MoSiV	BH11	X38CrMoV5	4X5MoC
SKD61	H13	X40CrMoV5-1 1.2344	4Cr5MoSiV1	BH13	Z40CDV5	4X5Mo1C
SKD7	H10	X32CrMoV33 1.2365	3Cr3Mo3V	BH10	32DCV28	—
SKD8	H19	38CrCoW18-17-17 1.2661	3Cr3Mo3VCo3	BH19	—	—
SKD10	D2	X153CrMoV12 1.2379	Cr12Mo1V1	—	—	X12M1ø1

References

● Alloy Tool Steel (continued) P

JIS	AISI/ASTM	DIN/EN	GB	BS	AFNOR	ГОСТ
SKD11	D2 D4	—	Cr12MoV	BD2	X160CrMoV12	X12Mo
SKD12	A2	X100CrMoV5 1.2363	Cr5Mo1V	BA2	Z100CDV5	—

● Ferritic Stainless Steels M

JIS	AISI/ASTM	DIN/EN	GB	BS	AFNOR	ГОСТ
SUS405	405 S40500	X10CrAl13 1.4002	0Cr13Al 06Cr13Al	405S17	Z6CA13	—
SUS429	429 S42900	—	1Cr15 10Cr15 022Cr15NbTi	—	—	—
SUS430	430 S43000	X6Cr17 1.4016	1Cr17 10Cr15 S11710	430S17	Z8C17	12X17
SUS430F	430F S43020	X12CrMoS17	Y1Cr17 Y10Cr17	—	Z10CF17	—
SUS434	434 S43400	X6CrMo17-1 1.4113	1Cr17Mo 10Cr17Mo	434S17	Z8CD17.01	—

● Martensitic Stainless Steels M

JIS	AISI/ASTM	DIN/EN	GB	BS	AFNOR	ГОСТ
SUS410	410 S41010	X10Cr13 1.4006	12Cr13 1Cr13	410S21	Z13C13	12X13
SUS403	403 S40300	—	12Cr12 1Cr12	—	—	—
SUS444	444 S44400	X2CrMoTi18-2 1.4521	019Cr18Mo2NbTi 00Cr18Mo2	—	—	—
SUS416	416 S41600	X12CrS13 1.4005	Y12Cr13 Y1Cr13	416S21	Z12CF13	—
SUS420J1	420 S42000	X20Cr13 1.4021	20Cr13 2Cr13	420S29	Z20C13	20X13
SUS420J2	420 S42000	X30Cr13 1.4028	30Cr13 3Cr13	420S45	Z30C13	30X13
SUS420F	420G S42020	X29Cr13 1.4029	Y30Cr13 Y3Cr13	—	Z30CF13	—
SUS431	431 S43100	X17CrNi16-2	17Cr16Ni2	431S29	—	—
SUS440C	440C S44004	—	108Cr17 11Cr17	—	Z100CD17	—

● Stainless Steel (Precipitation Hardened Structure) M

JIS	AISI/ASTM	DIN/EN	GB	BS	AFNOR	ГОСТ
SUS630	630 S17400	X5CrNiCuNb16-4 1.4542	0Cr17Ni4Cu4Nb 06Cr17Ni4Cu4Nb	—	Z6CNU17.04	—
SUS631	631 S17700	X7CrNiAl17-7 1.4568	0Cr17Ni7Al 07Cr17Ni7Al	—	Z8CNA17.07	09X17H7 10

● Austenitic Stainless Steels M

JIS	AISI/ASTM	DIN/EN	GB	BS	AFNOR	ГОСТ
SUS201	201 S20100	X12CrMnNi17-7-5 1.4372	1Cr17Mn6Ni5N 12Cr17Mn6Ni5N	—	Z12CMN17-07Az	—
SUS202	202 S20200	X12CrMnNi18-9-5 1.4373	1Cr18Mn9Ni5N 12Cr18Mn9Ni5N	284S16	—	—
SUS301	301 S30100	X12CrNi17-7 1.4319 1.4310	1Cr17Ni7 12Cr17Ni7	—	Z12CN17.07	17X18H9
SUS302	302 S30200	X9CrNi18-9 1.4325	1Cr18Ni9 12Cr18Ni9	302S25	Z10CN18.09	12X18H9
SUS302B	302B S30215	—	1Cr18Ni9Si3 12Cr18Ni9Si3	—	—	—
SUS303	303 S30300	X8CrNiS18-9 X10CrNiS189 1.4305	Y1Cr18Ni9 Y12Cr18Ni9	303S21	Z10CNF18.09	—
SUS303Se	303Se S30323	—	Y12Cr18Ni9Se Y1Cr18Ni9Se	303S41	—	12X18H10E
SUS304	304 S30400	X5CrNi18-10 1.4301	0Cr18Ni9 06Cr19Ni10	304S31	Z6CN18.09	08X18H10
SUS304L	304L S30403	X2CrNi19-11 1.4306	00Cr19Ni10 022Cr19Ni10	304S11	Z2CN18.10	03X18H11
SUS304N1	304N S30451	X5CrNiN19-9 1.4315	06Cr19Ni10N 06Cr19Ni10NbN	—	Z6CN19-09Az	—
SUS305	305 S30500	X2CrNi18-10 1.4311	1Cr18Ni12 10Cr18Ni12	305S19	Z8CN18.12	—
SUS309S	309S S30908	X6CrNi23-13 1.4950	0Cr23Ni13 06Cr23Ni13	—	—	0X23H12
SUS310S	310S S31008	X6CrNi25-20 1.4951	0Cr25Ni20 06Cr25Ni20	—	—	08X23H20
SUS316	316 S31600	X5CrNiMo17-12-2 1.4401	0Cr17Ni12Mo2 06Cr17Ni12Mo2	316S31	Z7CND17.12	—
SUS316L	316L S31603	X2CrNiMo17-12-2 1.4404	00Cr17Ni12Mo2 022Cr17Ni12Mo2	316S11	Z2CND17.12	03X17H14M2
SUS316N	316N S31651	—	0Cr17Ni12Mo2N 06Cr17Ni12Mo2N	—	—	—
SUS317	317 S31700	—	0Cr19Ni13Mo3 06Cr19Ni13Mo3	317S16	—	—
SUS317L	317L S31703	X2CrNiMo18-15-4 1.4438	00Cr19Ni13Mo3 022Cr19Ni13Mo3	317S12	Z2CND19.15	03X19H13M3
SUS321	321 S32100	X6CrNiTi18-10 1.4541	0Cr18Ni10Ti 06Cr18Ni10Ti	321S31	Z6CNT18.10	08X18H10T
SUS347	347 S34700	X6CrNiNb18-10 1.4550	0Cr18Ni11Nb 06Cr18Ni11Nb	347S31	Z6CNNb18.10	08X18H125

● Ferritic Heat Resistant Steels S

JIS	AISI/ASTM	DIN/EN	GB	BS	AFNOR	ГОСТ
SUH409	409 S40900	X6CrTi12	06Cr11Ti 0Cr11Ti1	409S19	Z6CT12	—
SUH446	446 S44600	—	2Cr25N 16Cr25N	—	Z12C24	—

● Martensitic Heat Resistant Steel S

JIS	AISI/ASTM	DIN/EN	GB	BS	AFNOR	ГОСТ
SUH1	—	—	45Cr9Si3	401S45	Z4CS9	—
SUH3	—	—	4Cr10Si2Mo 40Cr10Si2Mo	—	Z40CS10	40X10C2M
SUH4	—	—	8Cr20Si2Ni 80Cr20Si2Ni	443S65	Z80CSN20.02	—

● Martensitic Heat Resistant Steel (continued) S

JIS	AISI/ASTM	DIN/EN	GB	BS	AFNOR	ГОСТ
SUH11	—	—	4Cr9Si2 42Cr9Si2	—	—	40X 9C2
SUH600	—	—	2Cr12MoVNbN 18Cr12MoVNbN	—	—	—
SUH616	616 S42200	—	2Cr12NiMoWV 22Cr12NiWMoV	—	—	—

● Austenitic Heat Resistant Steel S

JIS	AISI/ASTM	DIN/EN	GB	BS	AFNOR	ГОСТ
SUH31	—	—	4Cr14Ni14W2Mo	331S42	—	45X14H14B2M
SUH35	—	X53CrMnNi21-9-4 1.4871	5Cr21Mn9Ni4N 53Cr21Mn9Ni4N	349S52	Z52CMN21.09	55X20G9AH4
SUH36	—	X53CrMnNi21 9	—	349S54	Z55CMN21-09Az	55X20G9AH4
SUH37	—	X15CrNiSi20-12 1.4828	22Cr21Ni12N 2Cr21Ni12N	381S34	—	—
SUH38	—	—	—	—	—	—
SUH309	309 S30900	X12CrNi23-13 1.4833	16Cr23Ni13 2Cr23Ni13	309S24	Z15CN24.13	20X23H12
SUH310	310 S31000	—	2Cr25Ni21 20Cr25Ni20	310S24	Z15CN25.20	—
SUH330	—	X12CrNiMoNi25-18-6S 1.4866	1Cr16Ni35 12Cr16Ni35	—	Z12NCS35.16	—

● Gray Cast Iron K

JIS	AISI/ASTM	DIN/EN	GB	BS	AFNOR	ГОСТ
FC100	No 20B	GG-10	HT100	100	—	Cy10
FC150	No 25B	GG-15	HT150	150	FGL150	Cy15
FC200	No 30B	GG-20	HT200	200	FGL200	Cy20
FC250	No 35B	GG-25	HT250	250	FGL250	Cy25
FC300	No 45B	GG-30	HT300	300	FGL300	Cy30
FC350	No 50B	GG-35	HT350	350	FGL350	Cy35

● Nodular Cast Iron K

JIS	AISI/ASTM	DIN/EN	GB	BS	AFNOR	ГОСТ
FCD400	60-40-18	GGG-40	QT400-18	400/17	FGS370-17	By40
FCD450	—	GGG-40.3	QT450-10	420/12	FGS400-12	By45
FCD500	80-55-06	GGG-50	QT500-7	500/7	FGS500-7	By50
FCD600	—	GGG-60	QT600-3	600/7	FGS600-2	By60
FCD700	100-70-03	GGG-70	QT700-2	700/2	FGS700-2	By70
FCD800	120-90-02	GGG-80	—	800/2	FGS800-2	By80

● Aluminum and Al Alloys - Sheets, plates and strips N

JIS	AISI/ASTM	DIN/EN	GB	BS	AFNOR	ГОСТ
A1060P	1060	EN AW-1060	L2	—	—	—
A1050P	1050	A199.50	1A50	—	—	—
A1100P	1100	EN AW-1100	L5-1	—	—	—
A1200P	1200	EN AW-1200	L5	EN AW-1200	EN AW-1200	—
A2014P	2014	EN AW-2014	LD10	EN AW-2014	EN AW-2014	—
A2017P	2017	EN AW-2017	2A11(LY11)	EN AW-2017	EN AW-2017	—
A2219P	2219	EN AW-2219	2A16(LY16)	—	—	—
A2024P	2024	EN AW-2024	2A12(LY12)	EN AW-2024	EN AW-2024	—
A2124P	2124	EN AW-2124	2A12(LY12)	—	—	—
A3003P	3003	EN AW-3003	LF21	EN AW-3003	EN AW-3003	—
A3004P	3004	EN AW-3004	3004	—	—	—
A3005P	3005	EN AW-3005	3005	—	—	—
A3015P	3105	EN AW-3105	3105	—	—	—
A5005P	5005	EN AW-5005	5005	—	—	—
A5005P	5050	EN AW-5050	—	—	—	—
A5052P	5052	EN AW-5052	5A02	EN AW-5052	EN AW-5052	—
A5154P	5154	—	LF3	—	—	—
A5254P	5254	—	LF3	—	—	—
A5454P	5454	EN AW-5454	5454	EN AW-5454	EN AW-5454	—
A5456P	5456	EN AW-5456	—	—	—	—
A6101P	6101	EN AW-6101	6101	—	—	—
A6061P	6061	EN AW-6061	6061(LD30)	EN AW-6061	EN AW-6061	—
A7075P	7075	EN AW-7075	7A04	EN AW-7075	EN AW-7075	—
A7178P	7178	EN AW-7178	7A03(LC3)	—	—	—

● Aluminum Alloy Die Castings N

JIS	AISI/ASTM	DIN/EN	GB	BS	AFNOR	ГОСТ
ADC1	A413.0	EN AC-44300	YL102	—	—	—
ADC3	A360.0	EN AC-43400	YL104	EN AC-43400	EN AC-43400	—
ADC5	518.0	—	Al-Mg7	—	—	—
ADC10	—	EN AC-46000	YL112	—	—	—
ADC12	—	—	YL113	LM20	—	—
ADC14	B390.0	—	—	—	—	—
AC4C	357	G-AISi7Mg	ZAlSi7Mg1A	LM25	A-S7G-03	—
AC4CH	356	G-AISi7Mg	ZAlSi7Mg	LM25	A-S7G	—
—	308	G-AISi6Cu4	ZAlSi6Cu6Mg	LM21	—	—

● Hardened Steel H

JIS	AISI/ASTM	DIN/EN	GB	BS	AFNOR	ГОСТ
C4BS	440A	X100CrMo13	7Cr17	—	—	—
AC4A	610	X110CrMoV15	—	—	—	—
AC4A	0-2	X65CrMo14	—	—	—	—

References

■ Steel and Non-Ferrous Metal Symbols Chart (Excerpt)

● Classifications and Symbols of Steels

Classification	Material	Symbol	Code Description	
Structural Steel	Rolled Steels for welded structures	SM	"M" for "Marine": Usually used in welded marine structures	
	Re-rolled Steels	SRB	"R" for "Re-rolled" and "B" for "Bar"	
	Rolled steel for general structures	SS	S for "Steel" and S for "Structure"	
	Light gauge sections for general structures	SSC	"C" for "Cold" after SS	
Steel Sheets	Hot rolled mild steel sheets / plates in coil form	SPH	P for "Plate" and "H" for "Hot"	
Steel Tubes	Carbon steel tubes for piping	SGP	"GP" for "Gas Pipe"	
	Carbon steel tubes for boiler and heat exchangers	STB	"T" for "Tube" and "B" for "Boiler"	
	Seamless steel tubes for high-pressure gas cylinders	STH	"H" for "High Pressure" after ST	
	Carbon steel tubes for general structures	STK	"K" for "Kozo" ("structure" in Japanese) after ST	
	Carbon steel tubes for mechanical structures	STKM	"M" for "Machine" after STK	
	Alloy steel tubes for structures	STKS	"S" for "Special" after STK	
	Alloy steel tubes for piping	STPA	"A" for "Alloy" after STP	
	Carbon steel tubes for pressure piping	STPG	"P" for "Piping" and "G" for "General" after ST	
	Carbon steel tubes for high-temperature piping	STPT	"T" for "Temperature" after ST	
	Carbon steel tubes for high-pressure piping	STS	"S" for "Special" after ST	
	Stainless steel tubes for piping	SUS-TP	"T" for "Tube" and "P" for "Piping" after SUS	
	Steel for Mechanical Structures	Carbon steels for mechanical structures	SxxC	"C" for "Carbon"
		Aluminum-chromium-molybdenum steels	SACM	"A" for "Al", "C" for "Cr" and "M" for "Mo"
		Chromium molybdenum steels	SCM	"C" for "Cr" and "M" for "Mo"
Chromium steels		SCr	"Cr" for "Chromium" after "S" for "Steel"	
Nickel Chromium steels		SNC	"N" for "Nickel" and "C" for "Chromium"	
Nickel Chromium Molybdenum steels		SNCM	"M" for "Molybdenum" in SNC	
Manganese steels and manganese chromium steels for mechanical structures		SMn SMnC	"Mn" for "Manganese" "C" for "Chromium" in SMn	
Carbon tool steels		SK	"K" for "Kogu" ("tool" in Japanese)	
Hollow drill steels		SKC	"C" for "Chisel" after SK	
Alloy tool steel		SKS SKD SKT	S for "Special" after SK D for "Die" after SK T for "Tanzo" - Japanese word for "forging" after SK	
Special Steels	High-speed tool steels	SKH	"H" for "High speed" after SK	
	Free cutting sulphuric steels	SUM	"M" for "Machinability" after SU	
	High-carbon chromium bearing steels	SUJ	"J" for "Jikuuke" ("bearing" in Japanese) after SU	
	Spring steels	SUP	"P" for "Spring" after SU	
	Stainless Steel	SUS	"S" for "Stainless Steel" after SU	
	Heat-resistant Steel	SUH	"U" for "Special Usage" and "H" for "Heat"	
	Heat-resistant steel bars	SUH-B	"B" for "Bar" after SUH	
Forged Steels	Heat-resistant steel sheets	SUHP	"P" for "Plate" after SUH	
	Carbon steel forgings for general use	SF	"F" for "Forging"	
	Carbon steel booms and billets for forgings	SFB	"B" for "Billet" after SF	
	Chromium molybdenum steel forgings	SFCM	"C" for "Chromium" and "M" for "Molybdenum" after SF	
Cast Iron	Nickel Chromium Molybdenum steel forgings	SFNCM	"N" for "Nickel" in SFCM	
	Gray cast iron	FC	"F" for "Ferrous" and "C" for "Casting"	
	Spherical graphite / Ductile cast irons	FCD	"D" for "Ductile" after FC	
	Blackheart malleable cast irons	FCMB	"M" for "Malleable" and "B" for "Black" after FC	
	Whiteheart malleable cast irons	FCMW	"W" for "White" after FCM	
Cast Steels	Pearlite malleable cast iron	FCMP	"P" for "Pearlite" after FCM	
	Carbon cast steels	SC	"C" for "Casting"	
	Cast stainless steels	SCS	"S" for "Stainless Steel" after SC	
	Heat-resistant cast steels	SCH	"H" for "Heat" after SC	
High-manganese cast steels	SCMnH	"Mn" for "Manganese" and "H" for "High" after SC		

● Non-Ferrous Metals

Classification	Material	Symbol	
Copper and Copper Alloys	Copper and copper alloys - sheets, plates and strips	CxxxxP	
		CxxxxPP	
		CxxxxR	
	Copper and copper alloys - welded pipes and tubes	CxxxxBD	
		CxxxxBDS	
		CxxxxBE	
Aluminum and Aluminum Alloys	Aluminum and Al alloys - Sheets, plates and strips	CxxxxBF	
		AxxxxP	
	Aluminum and Al alloys Rods, bars and wires	AxxxxPC	
		AxxxxBE	
		AxxxxBD	
	Aluminum and Al alloys - Extruded shapes	AxxxxW	
		AxxxxS	
Aluminum and Al alloy castings	AxxxxFD		
	AxxxxFH		
Wrought Alloys Magnesium	Magnesium alloy sheets and plates	MP	
Material Nickel	Nickel-copper alloy sheets and plates	NCuP	
	Nickel-copper alloy rods and bars	NCuB	
Wrought Metals Titanium	Titanium rods and bars	TB	
Castings	Castings	Brass castings	YBxCx
		High-strength brass castings	HBxCx
		Bronze castings	BCx
		Phosphorus Bronze castings	PBCx
		Aluminum bronze castings	AIBCx
		Aluminum Alloy Castings	AC
		Magnesium alloy castings	MC
		Zinc alloy die castings	ZDCx
		Aluminum Alloy Die Castings	ADC
		Magnesium alloy die castings	MDC
		White metals	WJ
		Aluminum alloy castings for bearings	AJ
		Copper-lead alloy castings for bearings	KJ

References

■ Hardness Scale Comparison Chart

● Approximate corresponding values for steel hardness on the Brinell scale

Brinell 3,000kgf	Rockwell Hardness				Vickers 50kgf	Shore Hardness	Tensile Strength (GPa)
	A Scale 60kgf brale	B Scale 100kgf 1/10in ball HRB	C Scale 150kgf brale	D Scale 100kgf brale			
	HB	HRA	HRC	HRD			
—	85.6	—	68.0	76.9	940	97	—
—	85.3	—	67.5	76.5	920	96	—
—	85.0	—	67.0	76.1	900	95	—
767	84.7	—	66.4	75.7	880	93	—
757	84.4	—	65.9	75.3	860	92	—
745	84.1	—	65.3	74.8	840	91	—
733	83.8	—	64.7	74.3	820	90	—
722	83.4	—	64.0	73.8	800	88	—
712	—	—	—	—	—	—	—
710	83.0	—	63.3	73.3	780	87	—
698	82.6	—	62.5	72.6	760	86	—
684	82.2	—	61.8	72.1	740	—	—
682	82.2	—	61.7	72.0	737	84	—
670	81.8	—	61.0	71.5	720	83	—
656	81.3	—	60.1	70.8	700	—	—
653	81.2	—	60.0	70.7	697	81	—
647	81.1	—	59.7	70.5	690	—	—
638	80.8	—	59.2	70.1	680	80	—
630	80.6	—	58.8	69.8	670	—	—
627	80.5	—	58.7	69.7	667	79	—
601	79.8	—	57.3	68.7	640	77	—
578	79.1	—	56.0	67.7	615	75	—
555	78.4	—	54.7	66.7	591	73	2.06
534	77.8	—	53.5	65.8	569	71	1.98
514	76.9	—	52.1	64.7	547	70	1.89
495	76.3	—	51.0	63.8	528	68	1.82
477	75.6	—	49.6	62.7	508	66	1.73
461	74.9	—	48.5	61.7	491	65	1.67
444	74.2	—	47.1	60.8	472	63	1.59
429	73.4	—	45.7	59.7	455	61	1.51
415	72.8	—	44.5	58.8	440	59	1.46
401	72.0	—	43.1	57.8	425	58	1.39
388	71.4	—	41.8	56.8	410	56	1.33
375	70.6	—	40.4	55.7	396	54	1.26
363	70.0	—	39.1	54.6	383	52	1.22
352	69.3	(110.0)	37.9	53.8	372	51	1.18
341	68.7	(109.0)	36.6	52.8	360	50	1.13
331	68.1	(108.5)	35.5	51.9	350	48	1.10

Brinell 3,000kgf	Rockwell Hardness				Vickers 50kgf	Shore Hardness	Tensile Strength (GPa)
	A Scale 60kgf brale	B Scale 100kgf 1/10in ball HRB	C Scale 150kgf brale	D Scale 100kgf brale			
	HB	HRA	HRC	HRD			
321	67.5	(108.0)	34.3	50.1	339	47	1.06
311	66.9	(107.5)	33.1	50.0	328	46	1.03
302	66.3	(107.0)	32.1	49.3	319	45	1.01
293	65.7	(106.0)	30.9	48.3	309	43	0.97
285	65.3	(105.5)	29.9	47.6	301	—	0.95
277	64.6	(104.5)	28.8	46.7	292	41	0.92
269	64.1	(104.0)	27.6	45.9	284	40	0.89
262	63.6	(103.0)	26.6	45.0	276	39	0.87
255	63.0	(102.0)	25.4	44.2	269	38	0.84
248	62.5	(101.0)	24.2	43.2	261	37	0.82
241	61.8	100.0	22.8	42.0	253	36	0.80
235	61.4	99.0	21.7	41.4	247	35	0.78
229	60.8	98.2	20.5	40.5	241	34	0.76
223	—	97.3	(18.8)	—	234	—	—
217	—	96.4	(17.5)	—	228	33	0.73
212	—	95.5	(16.0)	—	222	—	0.71
207	—	94.6	(15.2)	—	218	32	0.69
201	—	93.8	(13.8)	—	212	31	0.68
197	—	92.8	(12.7)	—	207	30	0.66
192	—	91.9	(11.5)	—	202	29	0.64
187	—	90.7	(10.0)	—	196	—	0.62
183	—	90.0	(9.0)	—	192	28	0.62
179	—	89.0	(8.0)	—	188	27	0.60
174	—	87.8	(6.4)	—	182	—	0.59
170	—	86.8	(5.4)	—	178	26	0.57
167	—	86.0	(4.4)	—	175	—	0.56
163	—	85.0	(3.3)	—	171	25	0.55
156	—	82.9	(0.9)	—	163	—	0.52
149	—	80.8	—	—	156	23	0.50
143	—	78.7	—	—	150	22	0.49
137	—	76.4	—	—	143	21	0.46
131	—	74.0	—	—	137	—	0.45
126	—	72.0	—	—	132	20	0.43
121	—	69.8	—	—	127	19	0.41
116	—	67.6	—	—	122	18	0.40
111	—	65.7	—	—	117	15	0.38

1) Figures within the () are not commonly used.

2) Rockwell A, C and D scales utilise a diamond brale.

3) This chart was taken from the JIS Iron and Steel Handbook (1980).

References

■ Dimensional Tolerance of Standard Fittings [Excerpt from JIS B 0401 (1999)]

● Dimensional Tolerance Used for Shafts of Standard Fittings

Classification of Reference Dimensions (mm)		Shaft Tolerance Class																								Unit: μm										
or greater	or less	b9	c9	d8	d9	e7	e8	e9	f6	f7	f8	g5	g6	h5	h6	h7	h8	h9	js5	js6	js7	k5	k6	m5	m6	n6	p6	r6	s6	t6	u6	x6				
—	3	-140 -165	-60 -85	-20 -34	-20 -45	-14 -24	-14 -28	-14 -39	-6 -12	-6 -16	-8 -20	-2 -6	-2 -8	0 -4	0 -6	0 -10	0 -14	0 -25	±2	±3	±5	+4 0	+6 0	+6 +2	+8 +2	+10 +4	+12 +6	+16 +10	+20 +14	—	+24 +18	+26 +20				
3	6	-140 -170	-70 -100	-30 -48	-30 -60	-20 -32	-20 -38	-20 -50	-10 -18	-10 -22	-10 -28	-4 -9	-4 -12	0 -5	0 -8	0 -12	0 -18	0 -30	±2.5	±4	±6	+6 +1	+9 +1	+9 +4	+12 +4	+16 +8	+20 +12	+23 +15	+27 +19	—	+31 +23	+36 +28				
6	10	-150 -186	-80 -116	-40 -62	-40 -76	-25 -40	-25 -47	-25 -61	-13 -22	-13 -28	-13 -35	-5 -11	-5 -14	0 -6	0 -9	0 -15	0 -22	0 -36	±3	±4.5	±7.5	+7 +1	+10 +1	+12 +6	+15 +6	+19 +10	+24 +15	+28 +19	+32 +23	—	+37 +28	+43 +34				
10	14	-150 -193	-95 -138	-50 -77	-50 -93	-32 -50	-32 -59	-32 -75	-16 -27	-16 -34	-16 -43	-6 -14	-6 -17	0 -8	0 -11	0 -18	0 -27	0 -43	±4	±5.5	±9	+9 +1	+12 +1	+15 +7	+18 +7	+23 +12	+29 +18	+34 +23	+39 +28	—	+44 +33	+40 +33				
14	18	—	—	—	—	—	—	—	—	—	—	—	—	—	—	—	—	—	—	—	—	—	—	—	—	—	—	—	—	—	—	+54 +41	+67 +54			
18	24	-160 -212	-110 -162	-65 -98	-65 -117	-40 -61	-40 -73	-40 -92	-20 -33	-20 -41	-20 -53	-7 -16	-7 -20	0 -9	0 -13	0 -21	0 -33	0 -52	±4.5	±6.5	±10.5	+11 +2	+15 +2	+17 +8	+21 +8	+28 +15	+35 +22	+41 +28	+48 +35	—	+54 +41	+67 +54				
24	30	—	—	—	—	—	—	—	—	—	—	—	—	—	—	—	—	—	—	—	—	—	—	—	—	—	—	—	—	—	—	+54 +41	+61 +48	+77 +64		
30	40	-170 -232	-120 -182	-80 -119	-80 -142	-50 -75	-50 -89	-50 -112	-25 -41	-25 -50	-25 -64	-9 -20	-9 -25	0 -11	0 -16	0 -25	0 -39	0 -62	±5.5	±8	±12.5	+13 +2	+18 +2	+20 +9	+25 +9	+33 +17	+42 +26	+50 +34	+59 +43	—	+64 +48	+76 +60				
40	50	-180 -242	-130 -192	—	—	—	—	—	—	—	—	—	—	—	—	—	—	—	—	—	—	—	—	—	—	—	—	—	—	—	—	+70 +54	+86 +70			
50	65	-190 -264	-140 -214	-100 -146	-100 -174	-60 -90	-60 -106	-60 -134	-30 -49	-30 -60	-30 -76	-10 -23	-10 -29	0 -13	0 -19	0 -30	0 -46	0 -74	±6.5	±9.5	±15	+15 +2	+21 +2	+24 +11	+30 +11	+39 +20	+51 +32	+60 +41	+72 +53	+85 +66	+106 +87	—	—			
65	80	-200 -274	-150 -224	—	—	—	—	—	—	—	—	—	—	—	—	—	—	—	—	—	—	—	—	—	—	—	—	—	—	—	—	+62 +43	+78 +59	+94 +75	+121 +102	
80	100	-220 -307	-170 -257	-120 -174	-120 -207	-72 -107	-72 -126	-72 -159	-36 -58	-36 -71	-36 -90	-12 -27	-12 -34	-14 -39	-14 -25	-14 -40	-14 -63	-14 -100	±7.5	±11	±17.5	+18 +3	+25 +3	+28 +13	+35 +13	+45 +23	+59 +37	+73 +51	+93 +71	+113 +91	+146 +124	—	—			
100	120	-240 -327	-180 -267	—	—	—	—	—	—	—	—	—	—	—	—	—	—	—	—	—	—	—	—	—	—	—	—	—	—	—	—	+76 +54	+101 +79	+126 +104	+166 +144	
120	140	-260 -360	-200 -300	—	—	—	—	—	—	—	—	—	—	—	—	—	—	—	—	—	—	—	—	—	—	—	—	—	—	—	—	+88 +63	+117 +92	+147 +122	—	—
140	160	-280 -380	-210 -310	-145 -208	-145 -245	-85 -125	-85 -148	-85 -185	-43 -68	-43 -83	-43 -106	-14 -32	-14 -39	-14 -25	-14 -40	-14 -63	-14 -100	±9	±12.5	±20	+21 +3	+28 +3	+33 +15	+40 +15	+52 +27	+68 +43	+90 +65	+125 +100	+159 +134	—	—	—	—	—		
160	180	-310 -410	-230 -330	—	—	—	—	—	—	—	—	—	—	—	—	—	—	—	—	—	—	—	—	—	—	—	—	—	—	—	—	+93 +68	+133 +108	+171 +146	—	—
180	200	-340 -455	-240 -355	—	—	—	—	—	—	—	—	—	—	—	—	—	—	—	—	—	—	—	—	—	—	—	—	—	—	—	—	+106 +77	+151 +122	—	—	—
200	225	-380 -495	-260 -375	-170 -242	-170 -285	-100 -146	-100 -172	-100 -215	-50 -79	-50 -96	-50 -122	-15 -35	-15 -44	-15 -20	-15 -29	-15 -46	-15 -72	-15 -115	±10	±14.5	±23	+24 +4	+33 +4	+37 +17	+46 +17	+60 +31	+79 +50	+109 +80	+159 +130	—	—	—	—	—		
225	250	-420 -535	-280 -395	—	—	—	—	—	—	—	—	—	—	—	—	—	—	—	—	—	—	—	—	—	—	—	—	—	—	—	—	+113 +84	+169 +140	—	—	—
250	280	-480 -610	-300 -430	-190 -271	-190 -320	-110 -162	-110 -191	-110 -240	-56 -88	-56 -108	-56 -137	-17 -40	-17 -49	-17 -23	-17 -32	-17 -52	-17 -81	-17 -130	±11.5	±16	±26	+27 +4	+36 +4	+43 +20	+52 +20	+66 +34	+88 +56	+126 +94	—	—	—	—	—	—		
280	315	-540 -670	-330 -460	—	—	—	—	—	—	—	—	—	—	—	—	—	—	—	—	—	—	—	—	—	—	—	—	—	—	—	—	+130 +98	—	—	—	—
315	355	-600 -740	-360 -500	-210 -299	-210 -350	-125 -182	-125 -214	-125 -265	-62 -98	-62 -119	-62 -151	-18 -43	-18 -54	-18 -25	-18 -36	-18 -57	-18 -89	-18 -140	±12.5	±18	±28.5	+29 +4	+40 +4	+46 +21	+57 +21	+73 +37	+98 +62	+144 +108	—	—	—	—	—	—		
355	400	-680 -820	-400 -540	—	—	—	—	—	—	—	—	—	—	—	—	—	—	—	—	—	—	—	—	—	—	—	—	—	—	—	—	+150 +114	—	—	—	—
400	450	-760 -915	-440 -595	-230 -327	-230 -385	-135 -198	-135 -232	-135 -290	-68 -108	-68 -131	-68 -165	-20 -47	-20 -60	-20 -27	-20 -40	-20 -63	-20 -97	-20 -155	±13.5	±20	±31.5	+32 +5	+45 +5	+50 +23	+63 +23	+80 +40	+108 +68	+166 +126	—	—	—	—	—	—		
450	500	-840 -995	-480 -635	—	—	—	—	—	—	—	—	—	—	—	—	—	—	—	—	—	—	—	—	—	—	—	—	—	—	—	—	+172 +132	—	—	—	—

References

■ Dimensional Tolerance of Standard Fittings [Excerpt from JIS B 0401 (1999)]

● Dimensional Tolerance Used for Holes of Standard Fittings

Classification of Reference Dimensions (mm)		Hole Tolerance Class																							Unit: μm										
or greater	or less	B10	C9	C10	D8	D9	D10	E7	E8	E9	F6	F7	F8	G6	G7	H6	H7	H8	H9	H10	JS6	JS7	K6	K7	M6	M7	N6	N7	P6	P7	R7	S7	T7	U7	X7
—	3	+180 +140	+85 +60	+100 +60	+34 +20	+45 +20	+60 +20	+24 +14	+28 +14	+39 +14	+12 +6	+16 +6	+20 +6	+8 +2	+12 +2	+6 0	+10 0	+14 0	+25 0	+40 0	± 3	± 5	0 -6	0 -10	-2 -8	-2 -12	-4 -10	-4 -14	-6 -12	-6 -16	-10 -20	-14 -24	—	-18 -28	-20 -30
3	6	+188 +140	+100 +70	+118 +70	+48 +30	+60 +30	+78 +30	+32 +20	+38 +20	+50 +20	+18 +10	+22 +10	+28 +10	+12 +4	+16 +4	+8 0	+12 0	+18 0	+30 0	+48 0	± 4	± 6	+2 -6	+3 -9	-1 -9	0 -12	-5 -13	-4 -16	-9 -17	-8 -20	-11 -23	-15 -27	—	-19 -31	-24 -36
6	10	+208 +150	+116 +80	+138 +80	+62 +40	+76 +40	+98 +40	+40 +25	+47 +25	+61 +25	+22 +13	+28 +13	+35 +13	+14 +5	+20 +5	+9 0	+15 0	+22 0	+36 0	+58 0	± 4.5	± 7.5	+2 -7	+5 -10	-3 -12	0 -15	-7 -16	-4 -19	-12 -21	-9 -24	-13 -28	-17 -32	—	-22 -37	-28 -43
10	14	+220 +150	+138 +95	+165 +95	+77 +50	+93 +50	+120 +50	+50 +32	+59 +32	+75 +32	+27 +16	+34 +16	+43 +16	+17 +6	+24 +6	+11 0	+18 0	+27 0	+43 0	+70 0	± 5.5	± 9	+2 -9	+6 -12	-4 -15	0 -18	-9 -20	-5 -23	-15 -26	-11 -29	-16 -34	-21 -39	—	-26 -44	-33 -56
14	18	+244 +160	+162 +110	+194 +110	+98 +65	+117 +65	+149 +65	+61 +40	+73 +40	+92 +40	+33 +20	+41 +20	+53 +20	+20 +7	+28 +7	+13 0	+21 0	+33 0	+52 0	+84 0	± 6.5	± 10.5	+2 -11	+6 -15	-4 -17	0 -21	-11 -24	-7 -28	-18 -31	-14 -35	-20 -41	-27 -48	—	-33 -54	-46 -67
18	24	+270 +170	+182 +120	+220 +120	+119 +80	+142 +80	+180 +80	+75 +50	+89 +50	+112 +50	+41 +25	+50 +25	+64 +25	+25 +9	+34 +9	+16 0	+25 0	+39 0	+62 0	+100 0	± 8	± 12.5	+3 -13	+7 -18	-4 -20	0 -25	-12 -28	-8 -33	-21 -37	-17 -42	-25 -50	-34 -59	—	-39 -64	-51 -76
24	30	+280 +180	+192 +130	+230 +130	+119 +80	+142 +80	+180 +80	+75 +50	+89 +50	+112 +50	+41 +25	+50 +25	+64 +25	+25 +9	+34 +9	+16 0	+25 0	+39 0	+62 0	+100 0	± 8	± 12.5	+3 -13	+7 -18	-4 -20	0 -25	-12 -28	-8 -33	-21 -37	-17 -42	-25 -50	-34 -59	—	-45 -70	-61 -86
30	40	+310 +190	+214 +140	+260 +140	+146 +100	+174 +100	+220 +100	+90 +60	+106 +60	+134 +60	+49 +30	+60 +30	+76 +30	+29 +10	+40 +10	+19 0	+30 0	+46 0	+74 0	+120 0	± 9.5	± 15	+4 -15	+9 -21	-5 -24	0 -30	-14 -33	-9 -39	-26 -45	-21 -51	-30 -60	-42 -72	-55 -85	-76 -106	
40	50	+320 +200	+224 +150	+270 +150	+146 +100	+174 +100	+220 +100	+90 +60	+106 +60	+134 +60	+49 +30	+60 +30	+76 +30	+29 +10	+40 +10	+19 0	+30 0	+46 0	+74 0	+120 0	± 9.5	± 15	+4 -15	+9 -21	-5 -24	0 -30	-14 -33	-9 -39	-26 -45	-21 -51	-30 -60	-42 -72	-55 -85	-76 -106	
50	65	+360 +220	+257 +170	+310 +170	+174 +120	+207 +120	+260 +120	+107 +72	+126 +72	+159 +72	+58 +36	+71 +36	+90 +36	+34 +12	+47 +12	+22 0	+35 0	+54 0	+87 0	+140 0	± 11	± 17.5	+4 -18	+10 -25	-6 -28	0 -35	-16 -38	-10 -45	-30 -52	-24 -59	-38 -73	-58 -93	-78 -113	-111 -146	
65	80	+380 +240	+267 +180	+320 +180	+174 +120	+207 +120	+260 +120	+107 +72	+126 +72	+159 +72	+58 +36	+71 +36	+90 +36	+34 +12	+47 +12	+22 0	+35 0	+54 0	+87 0	+140 0	± 11	± 17.5	+4 -18	+10 -25	-6 -28	0 -35	-16 -38	-10 -45	-30 -52	-24 -59	-38 -73	-58 -93	-78 -113	-111 -146	
80	100	+420 +260	+300 +200	+360 +200	+208 +145	+245 +145	+305 +145	+125 +85	+148 +85	+185 +85	+68 +43	+83 +43	+106 +43	+39 +14	+54 +14	+25 0	+40 0	+63 0	+100 0	+160 0	± 12.5	± 20	+4 -21	+12 -28	-8 -33	0 -40	-20 -45	-12 -52	-36 -61	-28 -68	-50 -90	-85 -125	-119 -159		
100	120	+440 +280	+310 +210	+370 +210	+208 +145	+245 +145	+305 +145	+125 +85	+148 +85	+185 +85	+68 +43	+83 +43	+106 +43	+39 +14	+54 +14	+25 0	+40 0	+63 0	+100 0	+160 0	± 12.5	± 20	+4 -21	+12 -28	-8 -33	0 -40	-20 -45	-12 -52	-36 -61	-28 -68	-50 -90	-85 -125	-119 -159		
120	140	+470 +310	+330 +230	+390 +230	+208 +145	+245 +145	+305 +145	+125 +85	+148 +85	+185 +85	+68 +43	+83 +43	+106 +43	+39 +14	+54 +14	+25 0	+40 0	+63 0	+100 0	+160 0	± 12.5	± 20	+4 -21	+12 -28	-8 -33	0 -40	-20 -45	-12 -52	-36 -61	-28 -68	-50 -90	-85 -125	-119 -159		
140	160	+470 +310	+330 +230	+390 +230	+208 +145	+245 +145	+305 +145	+125 +85	+148 +85	+185 +85	+68 +43	+83 +43	+106 +43	+39 +14	+54 +14	+25 0	+40 0	+63 0	+100 0	+160 0	± 12.5	± 20	+4 -21	+12 -28	-8 -33	0 -40	-20 -45	-12 -52	-36 -61	-28 -68	-50 -90	-85 -125	-119 -159		
160	180	+525 +340	+355 +240	+425 +240	+242 +170	+285 +170	+355 +170	+146 +100	+172 +100	+215 +100	+79 +50	+96 +50	+122 +50	+44 +15	+61 +15	+29 0	+46 0	+72 0	+115 0	+185 0	± 14.5	± 23	+5 -24	+13 -33	-8 -37	0 -46	-22 -51	-14 -60	-41 -70	-33 -79	-63 -109	-113 -159			
180	200	+525 +340	+355 +240	+425 +240	+242 +170	+285 +170	+355 +170	+146 +100	+172 +100	+215 +100	+79 +50	+96 +50	+122 +50	+44 +15	+61 +15	+29 0	+46 0	+72 0	+115 0	+185 0	± 14.5	± 23	+5 -24	+13 -33	-8 -37	0 -46	-22 -51	-14 -60	-41 -70	-33 -79	-63 -109	-113 -159			
200	225	+565 +380	+375 +260	+445 +260	+242 +170	+285 +170	+355 +170	+146 +100	+172 +100	+215 +100	+79 +50	+96 +50	+122 +50	+44 +15	+61 +15	+29 0	+46 0	+72 0	+115 0	+185 0	± 14.5	± 23	+5 -24	+13 -33	-8 -37	0 -46	-22 -51	-14 -60	-41 -70	-33 -79	-63 -109	-113 -159			
225	250	+605 +420	+395 +280	+465 +280	+242 +170	+285 +170	+355 +170	+146 +100	+172 +100	+215 +100	+79 +50	+96 +50	+122 +50	+44 +15	+61 +15	+29 0	+46 0	+72 0	+115 0	+185 0	± 14.5	± 23	+5 -24	+13 -33	-8 -37	0 -46	-22 -51	-14 -60	-41 -70	-33 -79	-63 -109	-113 -159			
250	280	+690 +480	+430 +300	+510 +300	+271 +190	+320 +190	+400 +190	+162 +110	+191 +110	+240 +110	+88 +56	+108 +56	+137 +56	+49 +17	+69 +17	+32 0	+52 0	+81 0	+130 0	+210 0	± 16	± 26	+5 -27	+16 -36	-9 -41	0 -52	-25 -57	-14 -66	-47 -79	-36 -88	-74 -126	—	—	—	
280	315	+750 +540	+460 +330	+540 +330	+271 +190	+320 +190	+400 +190	+162 +110	+191 +110	+240 +110	+88 +56	+108 +56	+137 +56	+49 +17	+69 +17	+32 0	+52 0	+81 0	+130 0	+210 0	± 16	± 26	+5 -27	+16 -36	-9 -41	0 -52	-25 -57	-14 -66	-47 -79	-36 -88	-74 -126	—	—	—	
315	355	+830 +600	+500 +360	+590 +360	+299 +210	+350 +210	+440 +210	+182 +125	+214 +125	+265 +125	+98 +62	+119 +62	+151 +62	+54 +18	+75 +18	+36 0	+57 0	+89 0	+140 0	+230 0	± 18	± 28.5	+7 -29	+17 -40	-10 -46	0 -57	-26 -62	-16 -73	-51 -87	-41 -98	-87 -144	—	—	—	
355	400	+910 +680	+540 +400	+630 +400	+299 +210	+350 +210	+440 +210	+182 +125	+214 +125	+265 +125	+98 +62	+119 +62	+151 +62	+54 +18	+75 +18	+36 0	+57 0	+89 0	+140 0	+230 0	± 18	± 28.5	+7 -29	+17 -40	-10 -46	0 -57	-26 -62	-16 -73	-51 -87	-41 -98	-87 -144	—	—	—	
400	450	+1010 +760	+595 +440	+690 +440	+327 +230	+385 +230	+480 +230	+198 +135	+232 +135	+290 +135	+108 +68	+131 +68	+165 +68	+60 +20	+83 +20	+40 0	+63 0	+97 0	+155 0	+250 0	± 20	± 31.5	+8 -32	+18 -45	-10 -50	0 -63	-27 -67	-17 -80	-55 -95	-45 -108	-103 -166	—	—	—	
450	500	+1090 +840	+635 +480	+730 +480	+327 +230	+385 +230	+480 +230	+198 +135	+232 +135	+290 +135	+108 +68	+131 +68	+165 +68	+60 +20	+83 +20	+40 0	+63 0	+97 0	+155 0	+250 0	± 20	± 31.5	+8 -32	+18 -45	-10 -50	0 -63	-27 -67	-17 -80	-55 -95	-45 -108	-103 -166	—	—	—	

References

■ Dimensional Tolerance and Fittings [Excerpt from JIS B 0401 (1999)]

● Standard Fittings for Holes

Reference Hole	Shaft Tolerance Class																					
	Gap fitting				Intermediate fitting				Tight fitting													
H6				g5	h5	js5	k5	m5														
			f6	g6	h6	js6	k6	m6	n6*	p6*												
H7			f6	g6	h6	js6	k6	m6	n6	p6*	r6*	s6	t6	u6	x6							
			e7	f7	h7	js7																
H8				f7	h7																	
			e8	f8	h8																	
H9			d9	e9																		
			d8	e8	h8																	
H10	c9	d9	e9		h9																	
	b9	c9	d9																			

Note: *Exceptions may arise with these fittings depending on the dimension category.

● Standard Fittings for Shafts

Reference Shaft	Hole Tolerance Class																
	Gap fitting				Intermediate fitting				Tight fitting								
h5					H6	JS6	K6	M6	N6*	P6							
			F6	G6	H6	JS6	K6	M6	N6	P6*							
h6					F7	G7	H7	JS7	K7	M7	N7	P7*	R7	S7	T7	U7	X7
			E7	F7	H7												
h7					F8	H8											
h8			D8	E8	F8	H8											
			D9	E9	H9												
h9			D8	E8	H8												
		C9	D9	E9	H9												
	B10	C10	D10														

Note: *Exceptions may arise with these fittings depending on the dimension category.

● Correlation of Tolerance Zones in Standard Hole Fittings

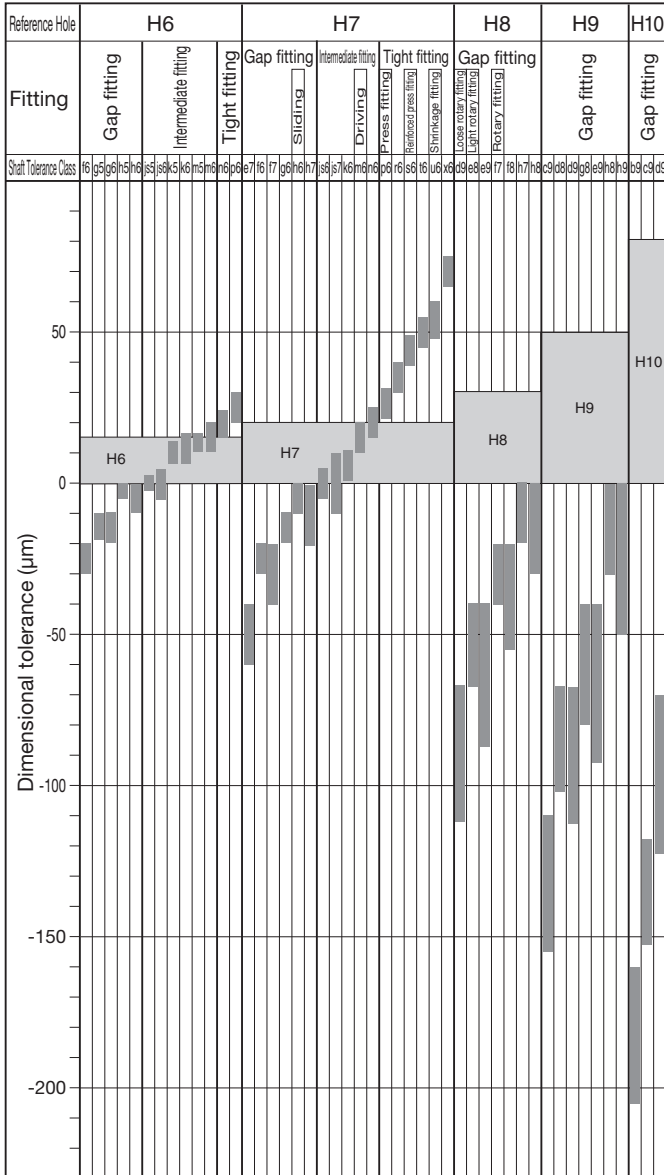

Note: The above table is for reference dimensions greater than 18mm up to 30mm.

● Correlation of Tolerance Zones in Standard Shaft Fittings

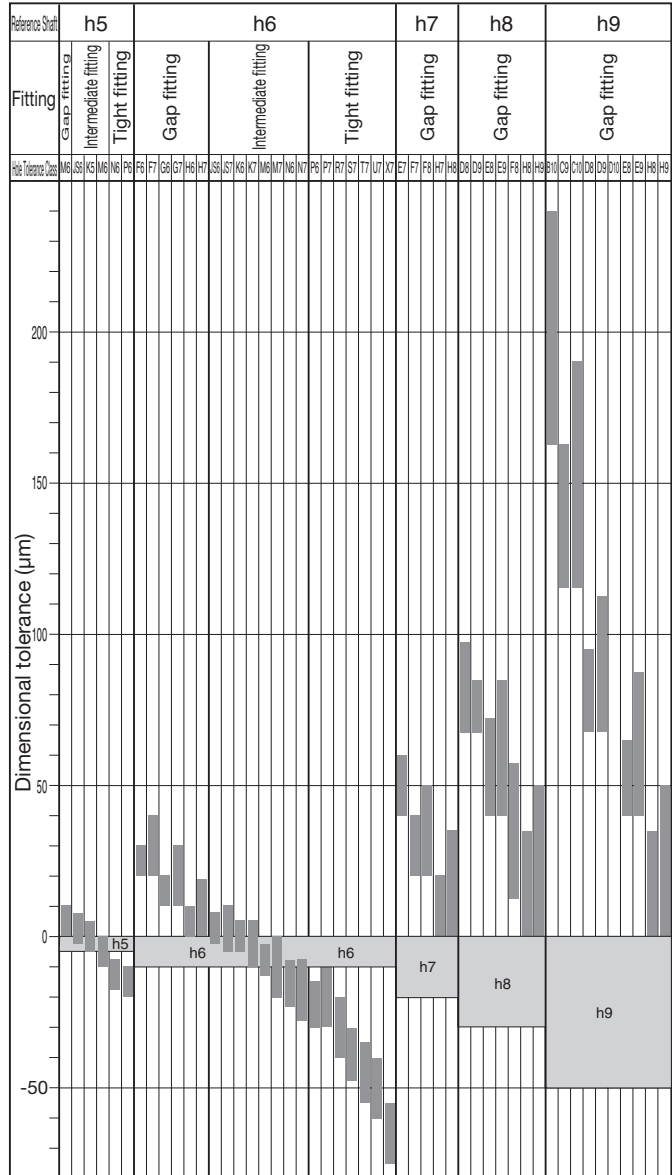

Note: The above table is for reference dimensions greater than 18mm up to 30mm.

References

Standard of Tapers

Morse Taper

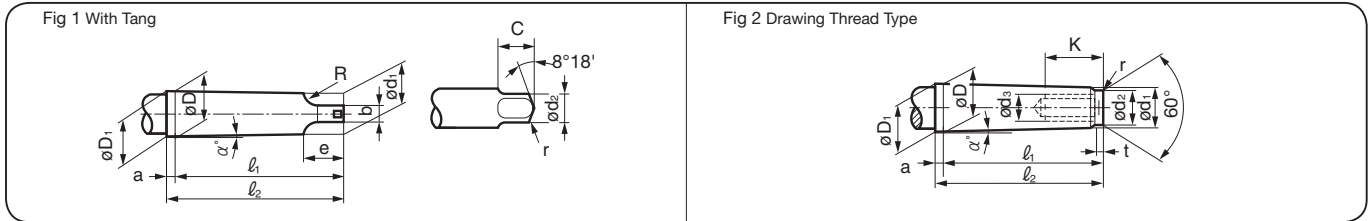

(Unit: mm)

Morse Taper Number	Taper ⁽¹⁾	Taper Angle (α)	Taper						Tang						Fig	
			D	a	D ₁ ⁽²⁾ (approx.)	d ₁ ⁽²⁾ (approx.)	l ₁ (Max)	l ₂ (Max)	d ₂ (Max)	b	C (Max)	e (Max)	R	r		
0	$\frac{1}{19.212}$	0.05205	1°29'27"	9.045	3	9.2	6.1	56.5	59.5	6.0	3.9	6.5	10.5	4	1	1
1	$\frac{1}{20.047}$	0.04988	1°25'43"	12.065	3.5	12.2	9.0	62.0	65.5	8.7	5.2	8.5	13.5	5	1.2	
2	$\frac{1}{20.020}$	0.04995	1°25'50"	17.780	5	18.0	14.0	75.0	80.0	13.5	6.3	10	16	6	1.6	
3	$\frac{1}{19.922}$	0.05020	1°26'16"	23.825	5	24.1	19.1	94.0	99.0	18.5	7.9	13	20	7	2	
4	$\frac{1}{19.245}$	0.05194	1°29'15"	31.267	6.5	31.6	25.2	117.5	124.0	24.5	11.9	16	24	8	2.5	
5	$\frac{1}{19.002}$	0.05263	1°30'26"	44.399	6.5	44.7	36.5	149.5	156.0	35.7	15.9	19	29	10	3	
6	$\frac{1}{19.180}$	0.05214	1°29'36"	63.348	8	63.8	52.4	210.0	218.0	51.0	19.0	27	40	13	4	
7	$\frac{1}{19.231}$	0.05200	1°29'22"	83.058	10	83.6	68.2	286.0	296.0	66.8	28.6	35	54	19	5	

Morse Taper Number	Taper ⁽¹⁾	Taper Angle (α)	Taper						Screw Part						Fig
			D	a	D ₁ ⁽²⁾ (approx.)	d ₁ ⁽²⁾ (approx.)	l ₁ (Max)	l ₂ (Max)	d ₂ (Max)	d ₃	K (Min)	t (Max)	r		
0	$\frac{1}{19.212}$	0.05205	1°29'27"	9.045	3	9.2	6.4	50	53	6	—	—	4	0.2	2
1	$\frac{1}{20.047}$	0.04988	1°25'43"	12.065	3.5	12.2	9.4	53.5	57	9	M 6	16	5	0.2	
2	$\frac{1}{20.020}$	0.04995	1°25'50"	17.780	5	18.0	14.6	64	69	14	M10	24	5	0.2	
3	$\frac{1}{19.922}$	0.05020	1°26'16"	23.825	5	24.1	19.8	81	86	19	M12	28	7	0.6	
4	$\frac{1}{19.254}$	0.05194	1°29'15"	31.267	6.5	31.6	25.9	102.5	109	25	M16	32	9	1	
5	$\frac{1}{19.002}$	0.05263	1°30'26"	44.399	6.5	44.7	37.6	129.5	136	35.7	M20	40	9	2.5	
6	$\frac{1}{19.180}$	0.05214	1°29'36"	63.348	8	63.8	53.9	182	190	51	M24	50	12	4	
7	$\frac{1}{19.231}$	0.05200	1°29'22"	83.058	10	83.6	70.0	250	260	65	M33	80	18.5	5	

Note (1) The fractional values are the taper standards.

(2) Diameters D₁ and d₁ are calculated from the diameter D value, the taper, a, and l₁ and rounded up to one decimal place.

Remark 1. Tapers are measured using JIS B 3301 ring gauges. At least 75% must be correct.

2. Screws must have metric coarse screw thread as per JIS B 0205 and Class 3 precision as per JIS B 0209.

Bottle Grip Taper

American Standard Taper (National Taper)

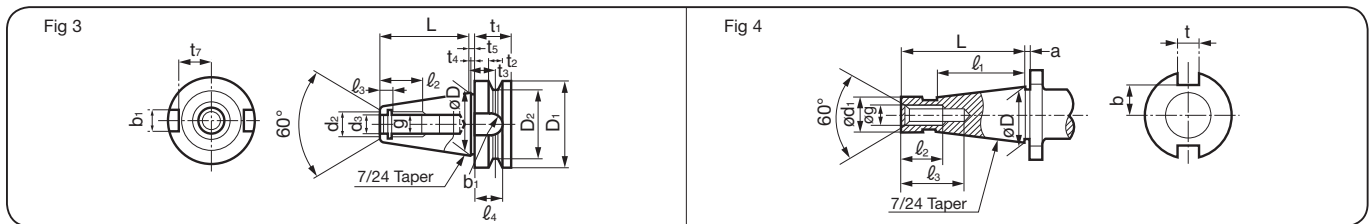

Bottle Grip Taper

(Units: mm)

Taper No.	D (Standard Dimensions)	D ₁	D ₂	t ₁	t ₂	t ₃	t ₄	t ₅	d ₂	d ₃	L	l ₂	l ₃	l ₄	g	b ₁	t ₇	Fig
BT30	31.75	46	38	20	8	13.6	2	2	14	12.5	48.4	24	7	17	M12	16.1	16.3	3
BT35	38.10	53	43	22	10	14.6	2	2	14	12.5	56.4	24	7	20	M12	16.1	19.6	
BT40	44.45	63	53	25	10	16.6	2	2	19	17	65.4	30	8	21	M16	16.1	22.6	
BT45	57.15	85	73	30	12	21.2	3	3	23	21	82.8	36	9	26	M20	19.3	29.1	
BT50	69.85	100	85	35	15	23.2	3	3	27	25	101.8	45	11	31	M24	25.7	35.4	
BT60	107.95	155	135	45	20	28.2	3	3	33	31	161.8	56	12	34	M30	25.7	60.1	

American Standard Taper (National Taper)

(Units: mm)

Taper No.	Nominal Size	D	d ₁	L	l ₁ (Min)	l ₂ (Min)	l ₃ (Min)	g	a	t	b	Fig
30	1 ¹ / ₄ "	31.750	17.4	68.4	48.4	24	34	1 ¹ / ₂ "	1.6	15.9	16	4
40	1 ³ / ₄ "	44.450	25.3	93.4	65.4	32	43	5 ⁹ / ₈ "	1.6	15.9	22.5	
50	2 ³ / ₄ "	69.850	39.6	126.8	101.8	47	62	1"	3.2	25.4	35	
60	4 ¹ / ₄ "	107.950	60.2	206.8	161.8	59	76	1 ¹ / ₄ "	3.2	25.4	60	

References

■ Surface Roughness

● Types and Definitions of Typical Surface Roughness

Type	Symbol	Method of Determination	Descriptive Figure
R Max.	¹⁾ Rz	This value is found by extracting the reference length in the mean line direction from the surface roughness curve, measuring the intervals between the peaks and valleys in the extracted area in the longitudinal magnification direction of the surface roughness curve, and expressing this value in micrometres (µm). Remarks: When finding Rz, any areas deemed to be scratches are removed before extracting the reference length from an area with no high peaks or low valleys.	
Calculated Roughness	Ra	This value is found by extracting the reference length in the mean line direction from the roughness curve, taking the average line direction of the extracted area as the X-axis and the longitudinal magnification direction as the Y-axis and expressing the value found by the equation below in micrometres (µm) with the roughness curve expressed by y=f(x).	
10-point Average Roughness	²⁾ Rz JIS	This value is found by extracting the reference length in the mean line direction from the roughness curve, finding the sum of the mean absolute peak height taken from the five highest peaks (Yp) and the mean absolute valley height taken from the five lowest valleys (Yv) measured in the longitudinal magnification direction from the mean line direction of the extracted area and expressing this value in micrometres (µm).	

Designated values for the above types of maximum height (Rz)¹⁾, 10-point average roughness (Rz JIS)²⁾, calculated average roughness (Ra) classifications, and reference length l are shown on the table at right with triangular symbols.

¹⁾ The maximum height symbol (Rz) is calculated according to the new **JIS B 0601:2001** standard. (This value was Ry under the old standard.)

²⁾ The 10-point average roughness (Rz JIS) is calculated according to the new **JIS B 0601:2001** standard. (This value was Rz under the old standard.)

● Relationship with triangular symbol display

Designated values for maximum height ¹⁾ (Rz)	Designated values for calculated average roughness (Ra)	Designated values for 10-point average roughness ²⁾ (Rz JIS)	Standard reference l length value (mm)	Triangular * Symbols	
(0.05) 0.1 0.2 0.4	(0.012) 0.025 0.05 0.10	(0.05) 0.1 0.2 0.4	0.25		
0.8	0.20	0.8			
1.6 3.2 6.3	0.40 0.80 1.6	1.6 3.2 6.3			0.8
12.5 (18) 25	3.2 6.3	12.5 (18) 25	2.5		
(35) 50 (70) 100	12.5 25	(35) 50 (70) 100			8
(140) 200 (280) 400 (560)	(50) (100)	(140) 200 (280) 400 (560)			—

Remarks: The designated values in () do not apply unless otherwise stated.

* Finish symbols (triangular symbol (▽) and tilde (-)) were removed from JIS in the 1994 revision.