

# Cut-off Tools

## F61 to F88

# F



Cut-off Tools		<b>SEC-Cut-off Tool Series Selection Guide</b> .....	<b>F62</b>
		<b>SumiGrip Introduction</b> .....	<b>F63</b>
	SumiGrip Jr.	<b>STFH Type</b> .....	<b>F64</b>
		<b>STFS Type</b> .....	<b>F66</b>
	SumiGrip	<b>WCFH Type</b> .....	<b>F68</b>
		<b>WCFS Type</b> .....	<b>F70</b>
	SEC-Small Diameter Cut-off Tool Holders	<b>SCT Type</b> .....	<b>F72</b>
	SEC-Cut-off Tool Holders	<b>GNDM Type / GNDML Type (For Small Lathes)</b> ...	<b>F74</b>
		<b>GNDM-J Type / GNDL-J Type (Internal Coolant Supply for Small Lathes)</b> .....	<b>F76</b>
		<b>GNDS Type</b> .....	<b>F78</b>
		<b>GNDM Type</b> .....	<b>F80</b>
		<b>GNDM-J Type (Internal Coolant Supply)</b> .....	<b>F82</b>
		<b>GNDL Type</b> .....	<b>F84</b>
		<b>GNDL-J Type (Internal Coolant Supply)</b> .....	<b>F86</b>

### Stock Markings and Symbols

- mark: Standard stocked item
- mark: To be replaced with the new item featured on the same page
- ▲ mark: To be replaced by a new product, made to order, or discontinued (please confirm stock availability).
- \* mark: Semi-standard stock (please confirm stock availability)
- mark: Stock or planned stock (please confirm stock availability)
- Blank: Made-to-order item
- mark: Not available

# Selection Guide

## Cut-off

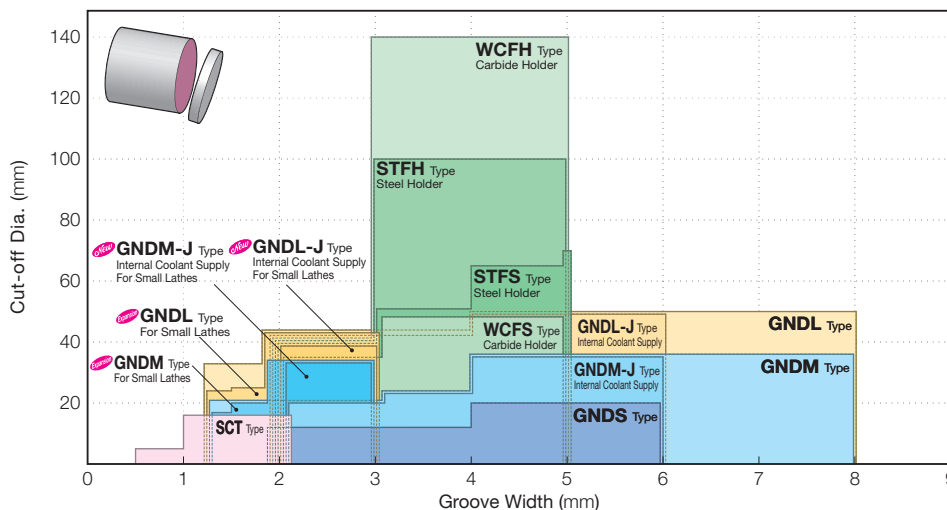

### Range of Applications (For Solid Workpieces)

Applications	Series	Shape	Insert Shape (1) indicates no. of cutting edges	Cut-off Dia. (mm)				Features		
				25	50	75	100			
				Groove Width (mm)						
				2	4	6	8	10		
For Small Lathes	<b>SCT</b>			16.0	2.0	0.5			<ul style="list-style-type: none"> <li>Ground insert with good sharpness</li> <li>Can clamp even from behind</li> <li>2-cornered type</li> </ul>	
For Small to Medium Diameters	<b>GNDM(-J)</b> For Small Lathes			32.0					<ul style="list-style-type: none"> <li>High-rigidity design and outstanding chip control</li> <li>Unground 2-cornered type</li> <li>Available with widths starting at 1.25mm</li> </ul>	
	<b>GNDL(-J)</b> For Small Lathes			1.25	3.0					
	<b>GNDS</b> <b>GNDM(-J)</b> <b>GNDL(-J)</b>				50.0	2.0	8.0			<ul style="list-style-type: none"> <li>High-rigidity body, rigid clamping</li> <li>Outstanding chip control</li> <li>Unground 2-cornered type</li> </ul>
For Medium to Large Diameters	<b>STFH</b> <b>STFS</b> (SumiGrip Jr.)			100.0	2.0	5.0		<ul style="list-style-type: none"> <li>Can be used for large diameter machining up to ø100mm</li> <li>Economical steel shank</li> <li>1-cornered self-grip type</li> </ul>		
	<b>WCFH</b> <b>WCFS</b> (SumiGrip)			140.0	2.0	5.0		<ul style="list-style-type: none"> <li>Can be used for large diameter machining up to ø140mm</li> <li>High-rigidity carbide shank</li> <li>1-cornered self-grip type</li> </ul>		

### Cut-off Tool Series

SEC-Small Diameter Cut-off Tool Holders <b>SCT Type</b>		<ul style="list-style-type: none"> <li>Our first recommendation for small lathes</li> <li>Excellent sharpness suppresses cutting resistance and central pips.</li> </ul>	
SEC-Cut-off Tool Holders <b>GND Type</b> (GNDS Type / GNDM(-J) Type / GNDL(-J) Type)		<ul style="list-style-type: none"> <li>Our first recommendation for small to medium diameters</li> <li>Enables stable cutting off thanks to high-rigidity body and rigid clamping</li> </ul>	
SEC-Cut-off Tool Holders <b>SumiGrip Jr.</b> Steel Shank <b>SumiGrip</b> Carbide Shank		<ul style="list-style-type: none"> <li>Our first recommendation for medium to large diameters</li> <li>Blade type is also provided to enable cutting off up to ø140mm</li> </ul>	

# SumiGrip

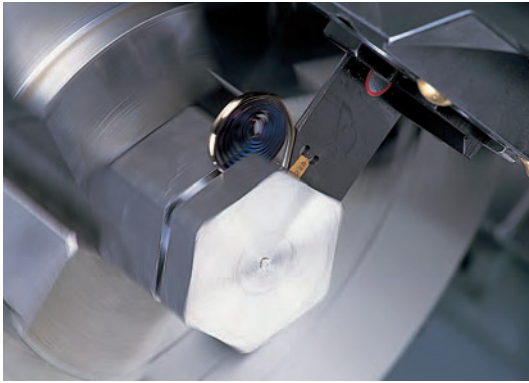

## ■ Features

- Available in cemented carbide holder (Sumi Grip) and steel holder (Sumi Grip Jr.)
- Capable of interrupted machining.
- Can be used for cutting off, grooving, chamfering, etc.

## ■ Types

- (1) Tool Block Type
  - STFH Type (Steel)/
  - WCFH Type (Carbide)
- (2) Shank Type
  - STFS Type (Steel)/
  - WCFS Type (Carbide)

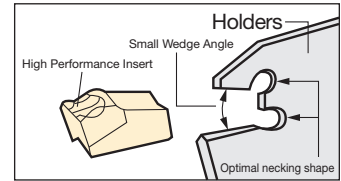

## ■ Cutting Performance (Holder)

### ● Insert Clamping Force

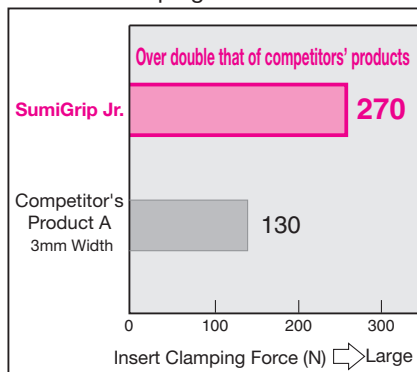

### ● Holder Overhang

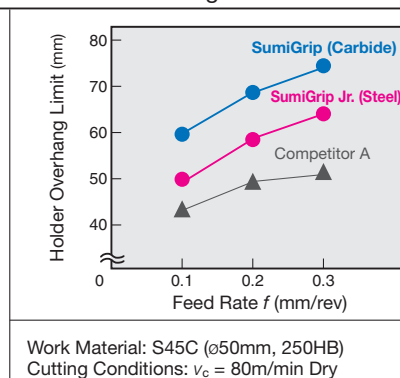

### ● Wear Resistance

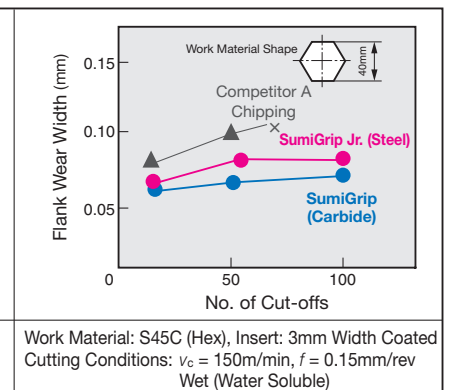

## ■ GG Type / GF Type / CF Type Chipbreaker + AC1030U

- Utilising grooving tool GND Type chipbreaker series for excellent chip control
- Low cutting force chipbreaker GF Type (neutral) or CF Type (handed) inserts, coupled with a carbide blade, enable stable machining and prevent chattering even when machining stainless steel.
- Achieving stable long tool life with the AC1030U grade.



## ■ Cutting Performance (Chipbreaker)

### ● Chip Control (Performance)



### ● Anti-Vibration Performance

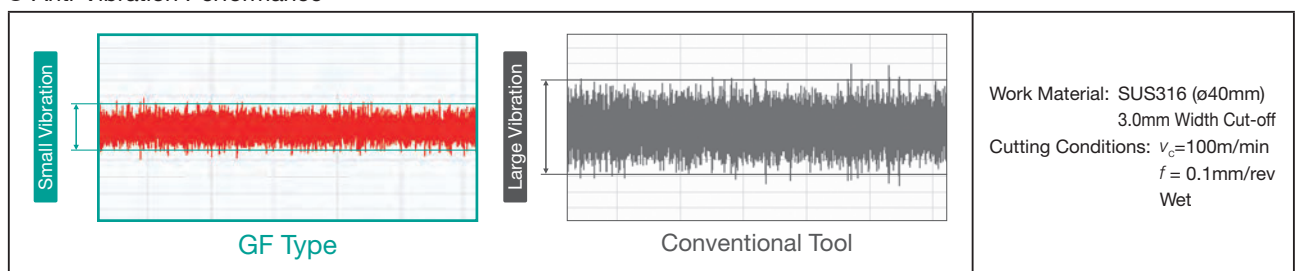

# STFH Type



Cut-off  
(Steel Holder/Tool Block Type)

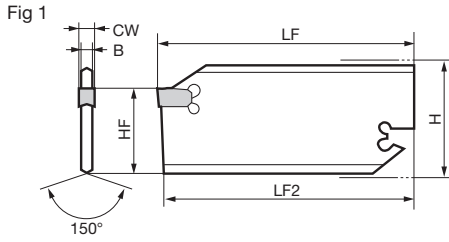
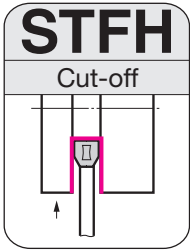

● Insert Mounting Method

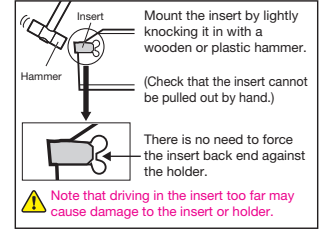

Grooving Tools  
F

Holder

Parts Dimensions (mm)

Cat. No.	Stock	Height H	Width B	Overall Length LF	Cutting Edge Height HF	Reference Length LF2	Width of Cut CW	Max. Cut-off Dia.	Applicable Insert	Applicable Tool Blocks	Fig	Wrench
STFH 26-2	●	26	1.6	109	21.4	108	2.0	40	WCFO2□		1	SL-4
STFH 26-3	●	26	2.4	109	21.4	108	3.0	70	WCFO3□	SBN 20-26 SBU 20-26	1	
STFH 26-4	●	26	3.4	109	21.4	108	4.0	70	WCFO4□		1	
STFH 26-5	●	26	4.3	109	21.4	108	5.0	70	WCFO5□		1	
STFH 32-2	●	32	1.6	149	25.0	148	2.0	40	WCFO2□	SBN 20-32	1	
STFH 32-3	●	32	2.4	149	25.0	148	3.0	100	WCFO3□	SBN 25-32	1	
STFH 32-4	●	32	3.4	149	25.0	148	4.0	100	WCFO4□	SBU 20-32	1	
STFH 32-5	●	32	4.3	149	25.0	148	5.0	100	WCFO5□	SBU 25-32	1	

\* The shape of STFH32-2 is slightly different from the above figure. Refer to F65 for applicable inserts.

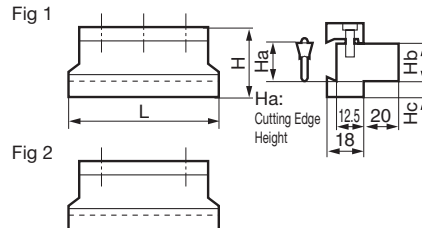
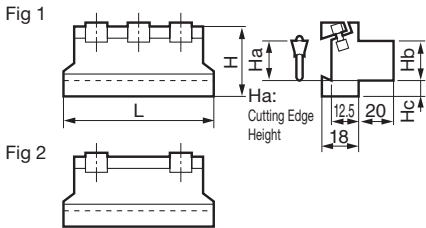

Tool Lock SBN Type (Integrated) Parts

Dimensions (mm)

Cat. No.	Stock	Cutting Edge Height Ha	Mounting Length Hb	Mounting Position Hc	Height H	Overall Length L	Fig	Clamp Plate	Double Screw	Wrench
SBN 20-26	●	20	20	10.0	45	80	2	BWS30	WB8-20	LH040
SBN 20-32	●	20	20	13.5	50	100	1			
SBN 25-32	●	25	25	8.5	50	110	1			

Tool Lock SBU Type (Split Type) Parts

Dimensions (mm)

Cat. No.	Stock	Cutting Edge Height Ha	Mounting Length Hb	Mounting Position Hc	Height H	Overall Length L	Fig	Clamp Wedge	Cap Screw	Wrench
SBU 20-26	●	20	20	10.0	45	80	2	BCS15		
SBU 20-32	●	20	20	13.5	50	100	1	BCS20	BX0622	LH050
SBU 25-32	●	25	25	8.5	50	110	1	BCS25		

Tool Block Type Selection Guide

Integrated type	<p>SBN Type Ex.: SBN20-32</p> <p>Applicable to toolpost <b>A</b> shown on the right.</p>	<p><b>A</b> General-purpose Lathe, etc. SBN Type SBU Type</p> <p>Toolpost Tool Block Spacer (Clamp from above)</p>	<p><b>B</b> Turret Type Toolpost, etc. SBU Type</p> <p>Toolpost Tool Block Wedge (Clamp from the side)</p>
	<p>SBU Type Ex.: SBU20-32</p> <p>Applicable to toolpost <b>A B</b> shown on the right.</p> <p>Large clamp plate ensures a wide clamp area that enables long holder overhang.</p>		

# SumiGrip Jr. STFH Type

Fig. 1 (Neutral (N))

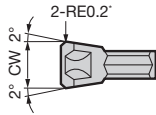

Fig. 2 (Right Hand (R))

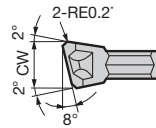
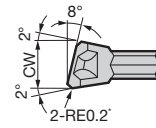

Fig. 3 (Left Hand (L))



\*WCF□ 2T: 2-RE0.15

Inserts for STFH (SumiGrip / SumiGrip Jr. common) ( Coated Carbide / Cermet / Cemented Carbide) Dimensions (mm)

Appearance	Cat. No.	Material						Width of Cut CW	Applicable Holders	Fig
		AC830P	AC225	AC1030U	T1500A	A30	G10E			
WCF NO-GG General-purpose	WCF N2-GG	●	—	—	—	—	—	2.0	STFH ○○-2	1
	WCF N3-GG	●	—	—	—	—	—	3.0	STFH ○○-3	1
	WCF N4-GG	●	—	—	—	—	—	4.0	STFH ○○-4	1
	WCF N5-GG	●	—	—	—	—	—	5.0	STFH ○○-5	1
WCF NO-GF Exotic Alloy Low Feed	WCF N2-GF	—	—	●	—	—	—	2.0	STFH ○○-2	1
	WCF N3-GF	—	—	●	—	—	—	3.0	STFH ○○-3	1
	WCF N4-GF	—	—	●	—	—	—	4.0	STFH ○○-4	1
	WCF N5-GF	—	—	●	—	—	—	5.0	STFH ○○-5	1
WCF □○-CF Exotic Alloy Low Feed (Handed)	WCF R3-CF	—	—	●	—	—	—	3.0	STFH ○○-3	2
	WCF L3-CF	—	—	●	—	—	—	3.0	STFH ○○-3	3
	WCF R4-CF	—	—	●	—	—	—	4.0	STFH ○○-4	2
	WCF L4-CF	—	—	●	—	—	—	4.0	STFH ○○-4	3
WCF □2T Small Diameter Low Resistance	WCF N2T	●	—	—	—	—	—	2.0	STFH ○○-2	1
	WCF R2T	●	—	—	—	—	—	2.0	STFH ○○-2	2
	WCF L2T	●	—	—	—	—	—	2.0	STFH ○○-2	3
WCF □○ No Chipbreaker For General Steel	WCF N3	●	—	—	—	—	—	3.0	STFH ○○-3	1
	WCF R3	●	—	—	—	—	—	3.0	STFH ○○-3	2
	WCF L3	●	—	—	—	—	—	3.0	STFH ○○-3	3
	WCF N4	●	—	—	—	—	—	4.0	STFH ○○-4	1
	WCF R4	●	—	—	—	—	—	4.0	STFH ○○-4	2
	WCF L4	●	—	—	—	—	—	4.0	STFH ○○-4	3
	WCF N5	●	—	—	—	—	—	5.0	STFH ○○-5	1
	WCF R5	●	—	—	—	—	—	5.0	STFH ○○-5	2
	WCF L5	●	—	—	—	—	—	5.0	STFH ○○-5	3
	WCF □○A Exotic Alloy Low Feed	WCF N2A	—	●	—	—	—	—	2.0	STFH ○○-2
WCF N3A		—	●	—	●	●	—	3.0	STFH ○○-3	1
WCF R3A		—	●	—	—	●	—	3.0	STFH ○○-3	2
WCF L3A		—	●	—	—	—	—	3.0	STFH ○○-3	3
WCF N4A		—	●	—	●	—	—	4.0	STFH ○○-4	1
WCF R4A		—	●	—	—	—	—	4.0	STFH ○○-4	2
WCF L4A		—	●	—	—	—	—	4.0	STFH ○○-4	3
WCF N5A		—	●	—	—	—	—	5.0	STFH ○○-5	1
WCF R5A		—	—	—	—	—	—	5.0	STFH ○○-5	2
WCF L5A		—	—	—	—	—	—	5.0	STFH ○○-5	3
WCF □○B Cast Iron Light Alloys	WCF N3B	—	—	—	—	●	—	3.0	STFH ○○-3	1
	WCF R3B	—	—	—	—	●	—	3.0	STFH ○○-3	2
	WCF L3B	—	—	—	—	●	—	3.0	STFH ○○-3	3
	WCF N4B	—	—	—	—	●	—	4.0	STFH ○○-4	1
	WCF R4B	—	—	—	—	●	—	4.0	STFH ○○-4	2
	WCF L4B	—	—	—	—	●	—	4.0	STFH ○○-4	3
	WCF N5B	—	—	—	—	●	—	5.0	STFH ○○-5	1
	WCF R5B	—	—	—	—	●	—	5.0	STFH ○○-5	2
	WCF L5B	—	—	—	—	●	—	5.0	STFH ○○-5	3

\*Same chipbreaker shape as the type for general steel (WCF□○), but with smaller cutting edge treatment.

## Recommended Cutting Conditions

Work Materials		Cutting Speed $v_c$ (m/min)					
		Coated Carbide			Cermet	Cemented Carbide	
		AC830P	AC225	AC1030U	T1500A	A30	G10E
P Steel	General Steel	80 to 200	80 to 200	50 to 200	80 to 200	50 to 120	—
	Mild Steel	100 to 230	100 to 230	50 to 230	100 to 230	70 to 150	—
	Die Steel	60 to 150	60 to 150	50 to 150	60 to 150	50 to 120	—
M Stainless Steel	70 to 150	60 to 150	50 to 150	—	70 to 130	—	
K Cast Iron	—	—	50 to 200	—	—	50 to 120	
N Non-ferrous Metal	—	—	200 to 500	—	—	200 to 500	

Chipbreaker	Feed Rate $f$ (mm/rev)										
	Neutral						Handed				
	GG	GF	No Chipbreaker	T	A	B	No Chipbreaker	CF	T	A	B
	General-purpose	Exotic Alloy/Low Cutting Force Type	General Steel	Small Diameter/Low Resistance	Exotic Alloy/Low Feed	Cast Iron/Light Alloys	General Steel	Exotic Alloy/Low Cutting Force Type	Small Diameter/Low Resistance	Exotic Alloy/Low Feed	Cast Iron/Light Alloys
Width of Cut	2.0	0.05 to 0.20	0.03 to 0.12	—	0.03 to 0.10	0.03 to 0.12	—	—	—	0.03 to 0.10	—
CW	3.0	0.08 to 0.25	0.04 to 0.15	0.08 to 0.25	—	0.04 to 0.15	0.05 to 0.15	0.08 to 0.25	0.05 to 0.12	—	0.04 to 0.15
(mm)	4.0	0.10 to 0.30	0.05 to 0.18	0.10 to 0.30	—	0.05 to 0.18	0.05 to 0.18	0.10 to 0.30	0.05 to 0.12	—	0.05 to 0.18
	5.0	0.10 to 0.35	0.05 to 0.20	0.10 to 0.30	—	0.05 to 0.20	0.06 to 0.20	0.10 to 0.30	—	—	0.06 to 0.20

Grooving Tools  
L  
Grooving  
Cut-off  
Threading  
External  
Face  
Internal  
Necking  
CBN

# SumiGrip Jr. STFS Type



For Cut-off  
(Steel Holder/Shank Type)

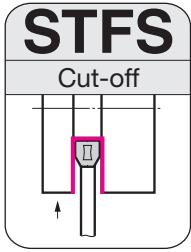

Fig 1

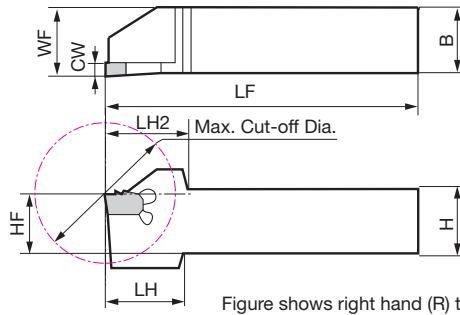
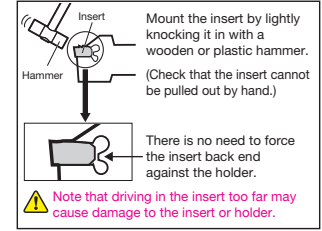

Figure shows right hand (R) tool.

### ● Insert Mounting Method



## Holder

Parts Dimensions (mm)

Cat. No.	Stock		Height H	Width B	Overall Length LF	Cutting Edge Distance WF	Cutting Edge Height HF	Head LH	Head LH2	Width of Cut CW	Max. Cut-off Dia.	Applicable Insert	Fig	Wrench
	R	L												SL-4
STFS R/L1010-2	●	●	10	10	86	10	10	17	17	2.0	28	WCFO2□	1	SL-4
STFS R/L1212-2	●	●	12	12	110	12	12	18	18	2.0	30			
STFS R/L1616-2	●	●	16	16	110	16	16	—	19	2.0	32			
STFS R/L2020-2	●	●	20	20	125	20	20	—	24	2.0	40			
STFS R/L1616-3	●	●	16	16	110	16	16	20	22	3.0	35	WCFO3□	1	SL-4
STFS R/L2012-3	●	●	20	12	110	12	20	—	24	3.0	40			
STFS R/L2020-3	●	●	20	20	125	20	20	—	30	3.0	50			
STFS R/L2525-3	●	●	25	25	150	25	25	—	30	3.0	50			
STFS R/L2020-4	●	●	20	20	125	20	20	—	33	4.0	55	WCFO4□	1	SL-4
STFS R/L2525-4	●	●	25	25	150	25	25	—	38	4.0	65			
STFS R/L2020-5	●	●	20	20	125	20	20	—	35	5.0	60	WCFO5□	1	SL-4
STFS R/L2525-5	●	●	25	25	150	25	25	—	40	5.0	70			

Refer to F67 for applicable inserts.

Grooving Tools

Grooving

Cut-off

Threading

External

Face

Internal

Necking

CBN

# SumiGrip Jr. STFS Type

Fig. 1 (Neutral (N))

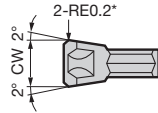

Fig. 2 (Right Hand (R))

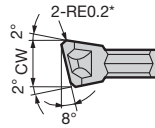
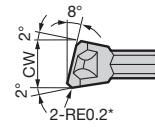

Fig. 3 (Left Hand (L))



\*WCF□ 2T: 2-RE0.15

Inserts for STFS (SumiGrip / SumiGrip Jr. common) (      Coated Carbide /      Cermet /      Cemented Carbide ) Dimensions (mm)

Appearance	Cat. No.	Material						Width of Cut CW	Applicable Holders	Fig
		AC830P	AC225	AC1030U	T1500A	A30	G10E			
WCF NO-GG General-purpose	WCF N2-GG	●	—	—	—	—	—	2.0	STFS R/L0000-2	1
	WCF N3-GG	●	—	—	—	—	—	3.0	STFS R/L0000-3	1
	WCF N4-GG	●	—	—	—	—	—	4.0	STFS R/L0000-4	1
	WCF N5-GG	●	—	—	—	—	—	5.0	STFS R/L0000-5	1
WCF NO-GF Exotic Alloy Low Feed	WCF N2-GF	—	—	●	—	—	—	2.0	STFS R/L0000-2	1
	WCF N3-GF	—	—	●	—	—	—	3.0	STFS R/L0000-3	1
	WCF N4-GF	—	—	●	—	—	—	4.0	STFS R/L0000-4	1
	WCF N5-GF	—	—	●	—	—	—	5.0	STFS R/L0000-5	1
WCF □○-CF Exotic Alloy Low Feed (Handed)	WCF R3-CF	—	—	●	—	—	—	3.0	STFS R/L0000-3	2
	WCF L3-CF	—	—	●	—	—	—	3.0	STFS R/L0000-3	3
	WCF R4-CF	—	—	●	—	—	—	4.0	STFS R/L0000-4	2
	WCF L4-CF	—	—	●	—	—	—	4.0	STFS R/L0000-4	3
WCF □2T Small Diameter Low Resistance	WCF N2T	●	—	—	—	—	—	2.0	STFS R/L0000-2	1
	WCF R2T	●	—	—	—	—	—	2.0	STFS R/L0000-2	2
	WCF L2T	●	—	—	—	—	—	2.0	STFS R/L0000-2	3
WCF □○ No Chipbreaker For General Steel	WCF N3	●	—	—	—	—	—	3.0	STFS R/L0000-3	1
	WCF R3	●	—	—	—	—	—	3.0	STFS R/L0000-3	2
	WCF L3	●	—	—	—	—	—	3.0	STFS R/L0000-3	3
	WCF N4	●	—	—	—	—	—	4.0	STFS R/L0000-4	1
	WCF R4	●	—	—	—	—	—	4.0	STFS R/L0000-4	2
	WCF L4	●	—	—	—	—	—	4.0	STFS R/L0000-4	3
	WCF N5	●	—	—	—	—	—	5.0	STFS R/L0000-5	1
	WCF R5	●	—	—	—	—	—	5.0	STFS R/L0000-5	2
	WCF L5	●	—	—	—	—	—	5.0	STFS R/L0000-5	3
	WCF □○A Exotic Alloy Low Feed	WCF N2A	—	●	—	—	—	—	2.0	STFS R/L0000-2
WCF N3A		—	●	—	●	●	—	3.0	STFS R/L0000-3	1
WCF R3A		—	●	—	—	●	—	3.0	STFS R/L0000-3	2
WCF L3A		—	●	—	—	—	—	3.0	STFS R/L0000-3	3
WCF N4A		—	●	—	●	—	—	4.0	STFS R/L0000-4	1
WCF R4A		—	●	—	—	—	—	4.0	STFS R/L0000-4	2
WCF L4A		—	●	—	—	—	—	4.0	STFS R/L0000-4	3
WCF N5A		—	●	—	—	—	—	5.0	STFS R/L0000-5	1
WCF R5A		—	—	—	—	—	—	5.0	STFS R/L0000-5	2
WCF L5A	—	—	—	—	—	—	5.0	STFS R/L0000-5	3	
WCF □○B Cast Iron Light Alloys	WCF N3B	—	—	—	—	●	—	3.0	STFS R/L0000-3	1
	WCF R3B	—	—	—	—	●	—	3.0	STFS R/L0000-3	2
	WCF L3B	—	—	—	—	●	—	3.0	STFS R/L0000-3	3
	WCF N4B	—	—	—	—	●	—	4.0	STFS R/L0000-4	1
	WCF R4B	—	—	—	—	●	—	4.0	STFS R/L0000-4	2
	WCF L4B	—	—	—	—	●	—	4.0	STFS R/L0000-4	3
	WCF N5B	—	—	—	—	●	—	5.0	STFS R/L0000-5	1
WCF R5B	—	—	—	—	●	—	5.0	STFS R/L0000-5	2	
WCF L5B	—	—	—	—	●	—	5.0	STFS R/L0000-5	3	

\*Same chipbreaker shape as the type for general steel (WCF□○), but with smaller cutting edge treatment.

## Recommended Cutting Conditions

Work Materials		Cutting Speed $v_c$ (m/min)					
		Coated Carbide			Cermet	Cemented Carbide	
		AC830P	AC225	AC1030U	T1500A	A30	G10E
P Steel	General Steel	80 to 200	80 to 200	50 to 200	80 to 200	50 to 120	—
	Mild Steel	100 to 230	100 to 230	50 to 230	100 to 230	70 to 150	—
	Die Steel	60 to 150	60 to 150	50 to 150	60 to 150	50 to 120	—
M Stainless Steel	70 to 150	60 to 150	50 to 150	—	70 to 130	—	
K Cast Iron	—	—	50 to 200	—	—	50 to 120	
N Non-ferrous Metal	—	—	200 to 500	—	—	200 to 500	

Chipbreaker		Feed Rate $f$ (mm/rev)										
		Neutral					Handed					
		GG	GF	No Chipbreaker	T	A	B	No Chipbreaker	CF	T	A	B
Width of Cut CW (mm)	2.0	0.05 to 0.20	0.03 to 0.12	—	0.03 to 0.10	0.03 to 0.12	—	—	—	0.03 to 0.10	—	—
	3.0	0.08 to 0.25	0.04 to 0.15	0.08 to 0.25	—	0.04 to 0.15	0.05 to 0.15	0.08 to 0.25	0.05 to 0.12	—	0.04 to 0.15	0.05 to 0.15
	4.0	0.10 to 0.30	0.05 to 0.18	0.10 to 0.30	—	0.05 to 0.18	0.05 to 0.18	0.10 to 0.30	0.05 to 0.12	—	0.05 to 0.18	0.05 to 0.18
	5.0	0.10 to 0.35	0.05 to 0.20	0.10 to 0.30	—	0.05 to 0.20	0.06 to 0.20	0.10 to 0.30	—	—	—	0.06 to 0.20

Grooving Tools  
Grooving  
Cut-off  
Threading  
External  
Face  
Internal  
Necking  
CBN

# SumiGrip WCFH Type



For Cut-off  
(Carbide Holder/Tool Block Type)

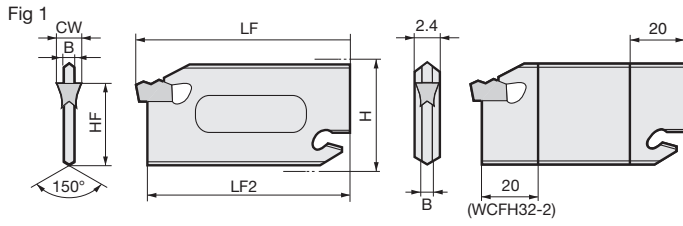
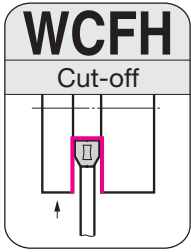
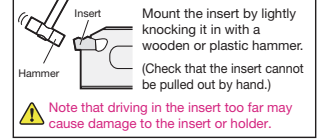

Figure shows right hand (R) tool.

### ● Insert Mounting Method



Grooving Tools

## Holder

Parts Dimensions (mm)

Cat. No.	Stock	Height H	Width B	Overall Length LF	Cutting Edge Height HF	Reference Length LF2	Width of Cut CW	Max. Cut-off Dia.	Applicable Insert	Applicable Tool Blocks	Fig	Wrench	
												Fig	Wrench
WCFH 26-2	●	26	1.7	110	21.4	109.0	2.0	40	WCF□2○	SBN 20-26 SBU 20-26	1	SL-2	
WCFH 26-3	●	26	2.4	110	21.4	108.5	3.0	80	WCF□3○		1		
WCFH 26-4	●	26	3.4	110	21.4	108.5	4.0	80	WCF□4○	SBN 20-32 SBN 25-32	1	SL-1	
WCFH 26-5	●	26	4.3	110	21.4	108.5	5.0	80	WCF□5○		1		
WCFH 32-2	●	32	1.7	150	25.0	149.0	2.0	40	WCF□2○	SBN 20-32 SBU 20-32	1	SL-2	
WCFH 32-3	●	32	2.4	150	25.0	148.5	3.0	140	WCF□3○		1		
WCFH 32-4	●	32	3.4	150	25.0	148.5	4.0	140	WCF□4○	SBN 20-32 SBU 25-32	1	SL-1	
WCFH 32-5	●	32	4.3	150	25.0	148.5	5.0	140	WCF□5○		1		

Refer to F69 for applicable inserts.

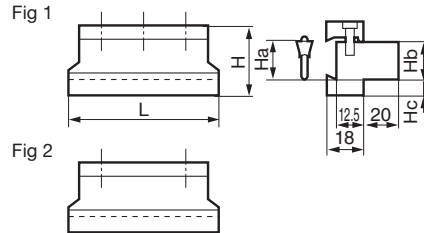
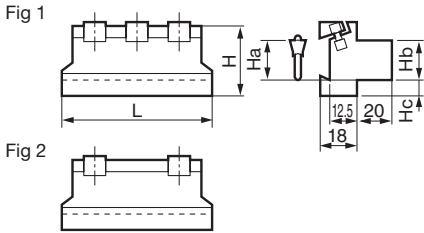

## Tool Lock SBN Type (Integrated)

Parts Dimensions (mm)

Cat. No.	Stock	Cutting Edge Height Ha	Mounting Length Hb	Mounting Position Hc	Height H	Overall Length L	Fig	Clamp Plate	Double Screw	Wrench
SBN 20-32	●	20	20	13.5	50	100	1	BWS30	WB8-20	LH040
SBN 25-32	●	25	25	8.5	50	110	1			

## Tool Lock SBU Type (Split Type)

Parts Dimensions (mm)

Cat. No.	Stock	Cutting Edge Height Ha	Mounting Length Hb	Mounting Position Hc	Height H	Overall Length L	Fig	Clamp Wedge	Cap Screw	Wrench
SBU 20-32	●	20	20	13.5	50	100	1	BCS20	BX0622	LH050
SBU 25-32	●	25	25	8.5	50	110	1	BCS25		

## Tool Block Type Selection Guide

Integrated type	<p>SBN Type Ex.: SBN20-32</p> <p>• Applicable to toolpost <b>A</b> shown on the right.</p>	<p><b>A</b> General-purpose Lathe, etc. SBN Type SBU Type</p> <p>Toolpost Tool Block Spacer (Clamp from above)</p>	<p><b>B</b> Turret Type Toolpost, etc. SBU Type</p> <p>Toolpost Tool Block Wedge (Clamp from the side)</p>
	<p>SBU Type Ex.: SBU20-32</p> <p>• Applicable to toolpost <b>A B</b> shown on the right. • Large clamp plate ensures a wide clamp area that enables long holder overhang.</p>		



# SumiGrip WCFH Type

Fig. 1 (Neutral (N))

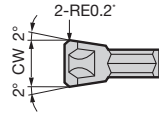

Fig. 2 (Right Hand (R))

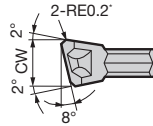
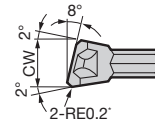

Fig. 3 (Left Hand (L))



\*WCF□ 2T: 2-RE0.15

Inserts for WCFH (SumiGrip / SumiGrip Jr. common) ( Coated Carbide / Cermet / Cemented Carbide) Dimensions (mm)

Appearance	Cat. No.	Material					Width of Cut CW	Applicable Holders	Fig
		AC830P	AC225	AC1030U	T1500A	A30			
WCF NO-GG General-purpose	WCF N2-GG	●	—	—	—	—	2.0	WCFH ○○-2	1
	WCF N3-GG	●	—	—	—	—	3.0	WCFH ○○-3	1
	WCF N4-GG	●	—	—	—	—	4.0	WCFH ○○-4	1
	WCF N5-GG	●	—	—	—	—	5.0	WCFH ○○-5	1
WCF NO-GF Exotic Alloy Low Feed	WCF N2-GF	—	●	—	—	—	2.0	WCFH ○○-2	1
	WCF N3-GF	—	●	—	—	—	3.0	WCFH ○○-3	1
	WCF N4-GF	—	●	—	—	—	4.0	WCFH ○○-4	1
	WCF N5-GF	—	●	—	—	—	5.0	WCFH ○○-5	1
WCF □○-CF Exotic Alloy Low Feed (Handed)	WCF R3-CF	—	●	—	—	—	3.0	WCFH ○○-3	2
	WCF L3-CF	—	●	—	—	—	3.0	WCFH ○○-3	3
	WCF R4-CF	—	●	—	—	—	4.0	WCFH ○○-4	2
	WCF L4-CF	—	●	—	—	—	4.0	WCFH ○○-4	3
WCF □2T Small Diameter Low Resistance	WCF N2T	●	—	—	—	—	2.0	WCFH ○○-2	1
	WCF R2T	●	—	—	—	—	2.0	WCFH ○○-2	2
	WCF L2T	●	—	—	—	—	2.0	WCFH ○○-2	3
WCF □○ No Chipbreaker For General Steel	WCF N3	●	—	—	—	—	3.0	WCFH ○○-3	1
	WCF R3	●	—	—	—	—	3.0	WCFH ○○-3	2
	WCF L3	●	—	—	—	—	3.0	WCFH ○○-3	3
	WCF N4	●	—	—	—	—	4.0	WCFH ○○-4	1
	WCF R4	●	—	—	—	—	4.0	WCFH ○○-4	2
	WCF L4	●	—	—	—	—	4.0	WCFH ○○-4	3
	WCF N5	●	—	—	—	—	5.0	WCFH ○○-5	1
	WCF R5	●	—	—	—	—	5.0	WCFH ○○-5	2
	WCF L5	●	—	—	—	—	5.0	WCFH ○○-5	3
WCF □○A Exotic Alloy Low Feed	WCF N2A	—	●	—	—	—	2.0	WCFH ○○-2	1
	WCF N3A	—	●	●	●	●	3.0	WCFH ○○-3	1
	WCF R3A	—	●	—	—	●	3.0	WCFH ○○-3	2
	WCF L3A	—	●	—	—	—	3.0	WCFH ○○-3	3
	WCF N4A	—	●	●	—	—	4.0	WCFH ○○-4	1
	WCF R4A	—	●	—	—	—	4.0	WCFH ○○-4	2
	WCF L4A	—	●	—	—	—	4.0	WCFH ○○-4	3
	WCF N5A	—	●	—	—	—	5.0	WCFH ○○-5	1
	WCF R5A	—	●	—	—	—	5.0	WCFH ○○-5	2
WCF L5A	—	●	—	—	—	5.0	WCFH ○○-5	3	
WCF □○B Cast Iron Light Alloys	WCF N3B	—	—	—	—	●	3.0	WCFH ○○-3	1
	WCF R3B	—	—	—	—	●	3.0	WCFH ○○-3	2
	WCF L3B	—	—	—	—	●	3.0	WCFH ○○-3	3
	WCF N4B	—	—	—	—	●	4.0	WCFH ○○-4	1
	WCF R4B	—	—	—	—	●	4.0	WCFH ○○-4	2
	WCF L4B	—	—	—	—	●	4.0	WCFH ○○-4	3
	WCF N5B	—	—	—	—	●	5.0	WCFH ○○-5	1
	WCF R5B	—	—	—	—	●	5.0	WCFH ○○-5	2
	WCF L5B	—	—	—	—	●	5.0	WCFH ○○-5	3

\*Same chipbreaker shape as the type for general steel (WCF□○), but with smaller cutting edge treatment.

## Recommended Cutting Conditions

Work Materials		Cutting Speed $v_c$ (m/min)					
		Coated Carbide			Cermet	Cemented Carbide	
		AC830P	AC225	AC1030U	T1500A	A30	G10E
P Steel	General Steel	80 to 200	80 to 200	50 to 200	80 to 200	50 to 120	—
	Mild Steel	100 to 230	100 to 230	50 to 230	100 to 230	70 to 150	—
	Die Steel	60 to 150	60 to 150	50 to 150	60 to 150	50 to 120	—
M Stainless Steel	70 to 150	60 to 150	50 to 150	—	70 to 130	—	
K Cast Iron	—	—	50 to 200	—	—	50 to 120	
N Non-ferrous Metal	—	—	200 to 500	—	—	200 to 500	

Chipbreaker		Feed Rate $f$ (mm/rev)										
		Neutral					Handed					
		GG	GF	No Chipbreaker	T	A	B	No Chipbreaker	CF	T	A	B
Width of Cut CW (mm)	2.0	0.05 to 0.20	0.03 to 0.12	—	0.03 to 0.10	0.03 to 0.12	—	—	—	0.03 to 0.10	—	—
	3.0	0.08 to 0.25	0.04 to 0.15	0.08 to 0.25	—	0.04 to 0.15	0.05 to 0.15	0.08 to 0.25	0.05 to 0.12	—	0.04 to 0.15	0.05 to 0.15
	4.0	0.10 to 0.30	0.05 to 0.18	0.10 to 0.30	—	0.05 to 0.18	0.05 to 0.18	0.10 to 0.30	0.05 to 0.12	—	0.05 to 0.18	0.05 to 0.18
	5.0	0.10 to 0.35	0.05 to 0.20	0.10 to 0.30	—	0.05 to 0.20	0.06 to 0.20	0.10 to 0.30	—	—	—	0.06 to 0.20

Grooving Tools

Grooving

Cut-off

Threading

External

Face

Internal

Necking

CBN

# SumiGrip WCFS Type



For Cut-off  
(Carbide Holder/Shank Type)

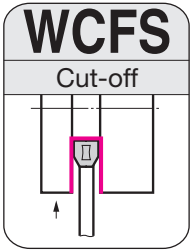

Brazed Blade Type

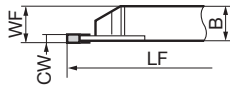

Fig 1

Blade Clamp Type

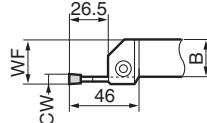

Fig 3

● Insert Mounting Method

Mount the insert by lightly knocking it in with a wooden or plastic hammer. (Check that the insert cannot be pulled out by hand.)

⚠ Note that driving in the insert too far may cause damage to the insert or holder.

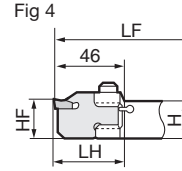
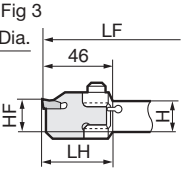
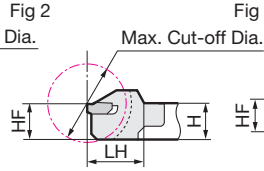
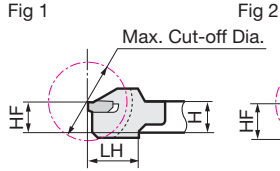

Figure shows right hand (R) tool.

Holder

Parts Dimensions (mm)

Type	Cat. No.	Stock		Height H	Width B	Overall Length LF	Cutting Edge Height HF	Head LH	Width of Cut CW	Max. Cut-off Dia.	Applicable Blades	Applicable Insert	Fig	Wrench
		R	L											
Brazed Type	WCFS R/L1010-2	●	●	10	10	86	10	10	2.0	28	—	WCF□2○	1	SL-2
	R/L1212-2	●	●	12	12	110	12	18	2.0	30	—	WCF□2○	1	
	R/L1616-2	●	●	16	16	100	16	25	2.0	35	—	WCF□2○	2	
	R/L1616-3	●	●	16	16	100	16	25	3.0	35	—	WCF□3○	2	
Clamp type	WCFS R/L20-3	●	●	20	20	125	20	46	3.0	50	WCFH17-3	WCF□3○	3	SL-1
	R/L20-4	●	●	20	20	125	20	46	4.0	50	WCFH17-4	WCF□4○	3	
	R/L20-5	●	●	20	20	125	20	46	5.0	50	WCFH17-5	WCF□5○	3	
	WCFS R/L25-3	●	●	25	25	150	25	46	3.0	50	WCFH17-3	WCF□3○	4	SL-1
	R/L25-4	●	●	25	25	150	25	46	4.0	50	WCFH17-4	WCF□4○	4	
	R/L25-5	●	●	25	25	150	25	46	5.0	50	WCFH17-5	WCF□5○	4	

Refer to F71 for applicable inserts. Blade is included with the holder.

Fig 1

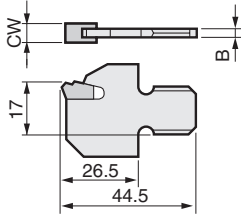

Blade

Dimensions (mm)

Cat. No.	Stock	Width of Cut CW	Width B	Applicable Holders
WCFH 17-3	●	3	2.4	WCFS R/L20-3,25-3
WCFH 17-4	●	4	3.4	WCFS R/L20-4,25-4
WCFH 17-5	●	5	4.3	WCFS R/L20-5,25-5

Parts

Applicable Holders	Cap Screw	Wrench
WCFS R/L20-○, WCFS R/L25-○	BX0622	LH050

Grooving Tools

T

Grooving

Cut-off

Threading

External

Face

Internal

Necking

CBN

# SumiGrip WCFS Type

Fig. 1 (Neutral (N))

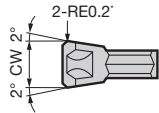

Fig. 2 (Right Hand (R))

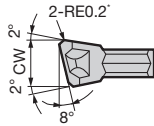
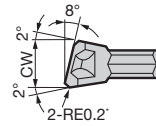

Fig. 3 (Left Hand (L))



\*WCF□ 2T: 2-RE0.15

Inserts for WCFS (SumiGrip / SumiGrip Jr. common) ( Coated Carbide / Cermet / Cemented Carbide ) Dimensions (mm)

Appearance	Cat. No.	Material						Width of Cut CW	Applicable Holders	Fig
		AC830P	AC225	AC1030U	T1500A	A30	G10E			
WCF NO-GG General-purpose	WCF N2-GG	●	—	—	—	—	—	2.0	WCFS R/L0000-2	1
	WCF N3-GG	●	—	—	—	—	—	3.0	WCFS R/L0000-3,WCFS R/LOO-3	1
	WCF N4-GG	●	—	—	—	—	—	4.0	WCFS R/LOO-4	1
	WCF N5-GG	●	—	—	—	—	—	5.0	WCFS R/LOO-5	1
WCF NO-GF Exotic Alloy Low Feed	WCF N2-GF	—	—	●	—	—	—	2.0	WCFS R/L0000-2	1
	WCF N3-GF	—	—	●	—	—	—	3.0	WCFS R/L0000-3,WCFS R/LOO-3	1
	WCF N4-GF	—	—	●	—	—	—	4.0	WCFS R/LOO-4	1
	WCF N5-GF	—	—	●	—	—	—	5.0	WCFS R/LOO-5	1
WCF □O-CF Exotic Alloy Low Feed (Handed)	WCF R3-CF	—	—	●	—	—	—	3.0	WCFS R/L0000-3	2
	WCF L3-CF	—	—	●	—	—	—	3.0	WCFS R/LOO-3	3
	WCF R4-CF	—	—	●	—	—	—	4.0	WCFS R/LOO-4	2
	WCF L4-CF	—	—	●	—	—	—	4.0	WCFS R/LOO-4	3
WCF □2T Small Diameter Low Resistance	WCF N2T	●	—	—	—	—	—	2.0	WCFS R/L0000-2	1
	WCF R2T	●	—	—	—	—	—	2.0	WCFS R/L0000-2	2
	WCF L2T	●	—	—	—	—	—	2.0	WCFS R/L0000-2	3
WCF □O No Chipbreaker For General Steel	WCF N3	●	—	—	—	—	—	3.0	WCFS R/L0000-3	1
	WCF R3	●	—	—	—	—	—	3.0	WCFS R/L0000-3	2
	WCF L3	●	—	—	—	—	—	3.0	WCFS R/LOO-3	3
	WCF N4	●	—	—	—	—	—	4.0	WCFS R/LOO-4	1
	WCF R4	●	—	—	—	—	—	4.0	WCFS R/LOO-4	2
	WCF L4	●	—	—	—	—	—	4.0	WCFS R/LOO-4	3
	WCF N5	●	—	—	—	—	—	5.0	WCFS R/LOO-5	1
	WCF R5	●	—	—	—	—	—	5.0	WCFS R/LOO-5	2
	WCF L5	●	—	—	—	—	—	5.0	WCFS R/LOO-5	3
	WCF □OA Exotic Alloy Low Feed	WCF N2A	—	●	—	—	—	—	2.0	WCFS R/L0000-2
WCF N3A		—	●	—	●	●	—	3.0	WCFS R/L0000-3	1
WCF R3A		—	●	—	—	●	—	3.0	WCFS R/L0000-3	2
WCF L3A		—	●	—	—	—	—	3.0	WCFS R/LOO-3	3
WCF N4A		—	●	—	●	—	—	4.0	WCFS R/LOO-4	1
WCF R4A		—	●	—	—	—	—	4.0	WCFS R/LOO-4	2
WCF L4A		—	●	—	—	—	—	4.0	WCFS R/LOO-4	3
WCF N5A		—	●	—	—	—	—	5.0	WCFS R/LOO-5	1
WCF R5A		—	●	—	—	—	—	5.0	WCFS R/LOO-5	2
WCF L5A		—	●	—	—	—	—	5.0	WCFS R/LOO-5	3
WCF □OB Cast Iron Light Alloys	WCF N3B	—	—	—	—	—	●	3.0	WCFS R/L0000-3	1
	WCF R3B	—	—	—	—	—	●	3.0	WCFS R/L0000-3	2
	WCF L3B	—	—	—	—	—	●	3.0	WCFS R/LOO-3	3
	WCF N4B	—	—	—	—	—	●	4.0	WCFS R/LOO-4	1
	WCF R4B	—	—	—	—	—	●	4.0	WCFS R/LOO-4	2
	WCF L4B	—	—	—	—	—	●	4.0	WCFS R/LOO-4	3
	WCF N5B	—	—	—	—	—	●	5.0	WCFS R/LOO-5	1
	WCF R5B	—	—	—	—	—	●	5.0	WCFS R/LOO-5	2
WCF L5B	—	—	—	—	—	●	5.0	WCFS R/LOO-5	3	

\*Same chipbreaker shape as the type for general steel (WCF□O), but with smaller cutting edge treatment.

## Recommended Cutting Conditions

Work Materials		Cutting Speed $v_c$ (m/min)					
		Coated Carbide			Cermet	Cemented Carbide	
		AC830P	AC225	AC1030U	T1500A	A30	G10E
P Steel	General Steel	80 to 200	80 to 200	50 to 200	80 to 200	50 to 120	—
	Mild Steel	100 to 230	100 to 230	50 to 230	100 to 230	70 to 150	—
	Die Steel	60 to 150	60 to 150	50 to 150	60 to 150	50 to 120	—
M Stainless Steel	70 to 150	60 to 150	50 to 150	—	70 to 130	—	
K Cast Iron	—	—	50 to 200	—	—	50 to 120	
N Non-ferrous Metal	—	—	200 to 500	—	—	200 to 500	

Chipbreaker	Feed Rate $f$ (mm/rev)										
	Neutral					Handed					
	GG	GF	No Chipbreaker	T	A	B	No Chipbreaker	CF	T	A	B
	General-purpose	Exotic Alloy/Low Cutting Force Type	General Steel	Small Diameter/Low Resistance	Exotic Alloy/Low Feed	Cast Iron/Light Alloys	General Steel	Exotic Alloy/Low Cutting Force Type	Small Diameter/Low Resistance	Exotic Alloy/Low Feed	Cast Iron/Light Alloys
Width of Cut CW (mm)	2.0	0.05 to 0.20	0.03 to 0.12	—	0.03 to 0.10	0.03 to 0.12	—	—	0.03 to 0.10	—	—
	3.0	0.08 to 0.25	0.04 to 0.15	0.08 to 0.25	—	0.04 to 0.15	0.05 to 0.15	0.08 to 0.25	0.05 to 0.12	—	0.04 to 0.15
	4.0	0.10 to 0.30	0.05 to 0.18	0.10 to 0.30	—	0.05 to 0.18	0.05 to 0.18	0.10 to 0.30	0.05 to 0.12	—	0.05 to 0.18
	5.0	0.10 to 0.35	0.05 to 0.20	0.10 to 0.30	—	0.05 to 0.20	0.06 to 0.20	0.10 to 0.30	—	—	0.06 to 0.20

Grooving Tools  
Grooving  
Cut-off  
Threading  
External  
Face  
Internal  
Necking  
CBN

# SCT Type

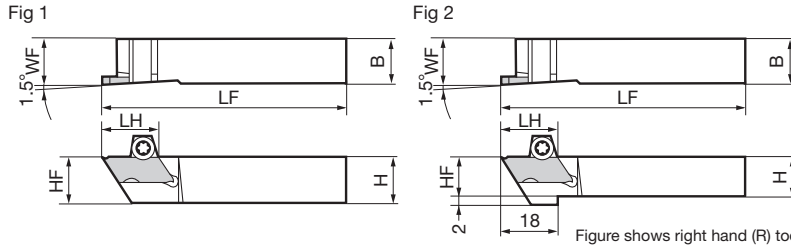
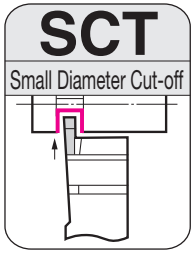

Figure shows right hand (R) tool.

Grooving Tools

F

Grooving

Cut-off

Threading

External

Face

Internal

Necking

CBN

## Holder (Right Handed)

## Parts Dimensions (mm)

Cat. No.	Stock	Height H	Width B	Overall Length LF	Cutting Edge Distance WF	Cutting Edge Height HF	Head LH	Applicable Insert	Fig	Screw	Wrench
SCT R1010	●	10	10	120	10	10	15	CT R050000(-NB)	1	BFTX0410T8L	TRX08
SCT R1212	●	12	12	120	12	12	15	CT R120000(-NB)	1		
SCT R1616	●	16	16	120	16	16	15		1		
SCT R1010-16	●	10	10	120	10	10	18	CT R160000(-NB)	2	BFTX0410T8L	TRX08
SCT R1212-16	●	12	12	120	12	12	18		1		
SCT R1616-16	●	16	16	120	16	16	18		1		

## Holder (Left Handed)

## Parts Dimensions (mm)

Cat. No.	Stock	Height H	Width B	Overall Length LF	Cutting Edge Distance WF	Cutting Edge Height HF	Head LH	Applicable Insert	Fig	Screw	Wrench
SCT L1010	●	10	10	120	10	10	15	CT L050000(-NB)	1	BFTX0410T8R	TRX08
SCT L1212	●	12	12	120	12	12	15	CT L120000(-NB)	1		
SCT L1616	●	16	16	120	16	16	15		1		
SCT L1010-16	●	10	10	120	10	10	18	CT L160000(-NB)	2	BFTX0410T8R	TRX08
SCT L1212-16	●	12	12	120	12	12	18		1		
SCT L1616-16	●	16	16	120	16	16	18		1		

## Feature

- **Simple Indexable Inserts**  
New clamping system makes it possible to change corners simply by loosening the screw from the back
- **High quality surface finish**  
Excellent chip removal with good surface finish even at the centre of the work material end face.
- **Long, Stable Tool Life**  
PVD Coating  
Long, stable tool life with AC1030U/AC530U

## Design Features

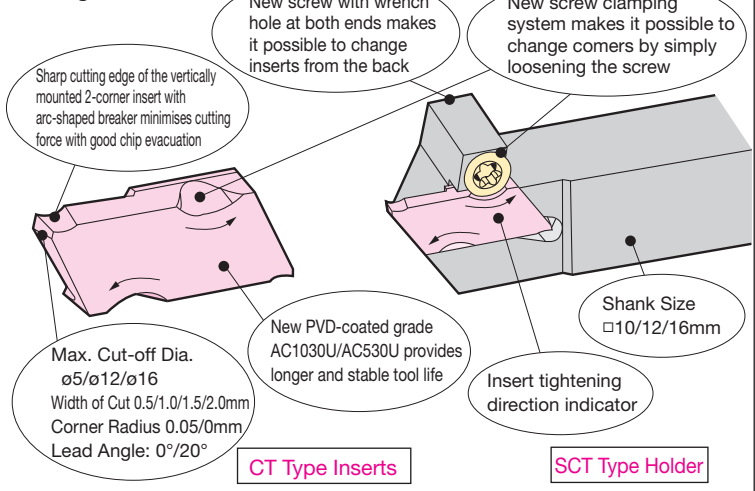

## Cutting Performance

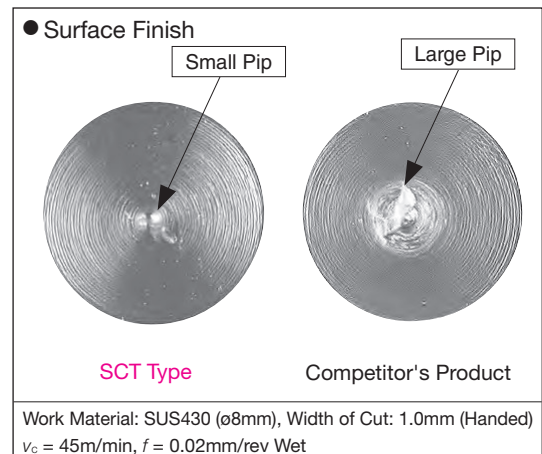
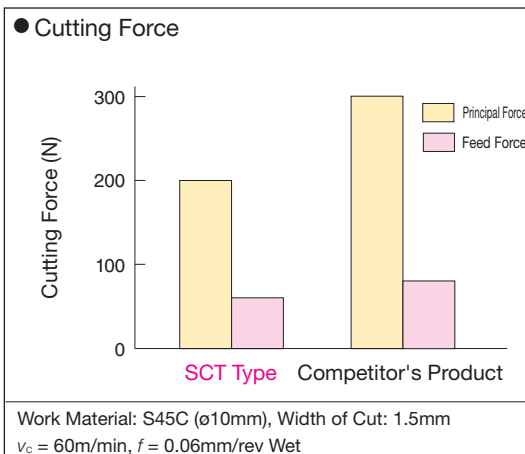

# SCT Type

Insert Mounting Status and Dimensions (Figure shows insert with chipbreaker)

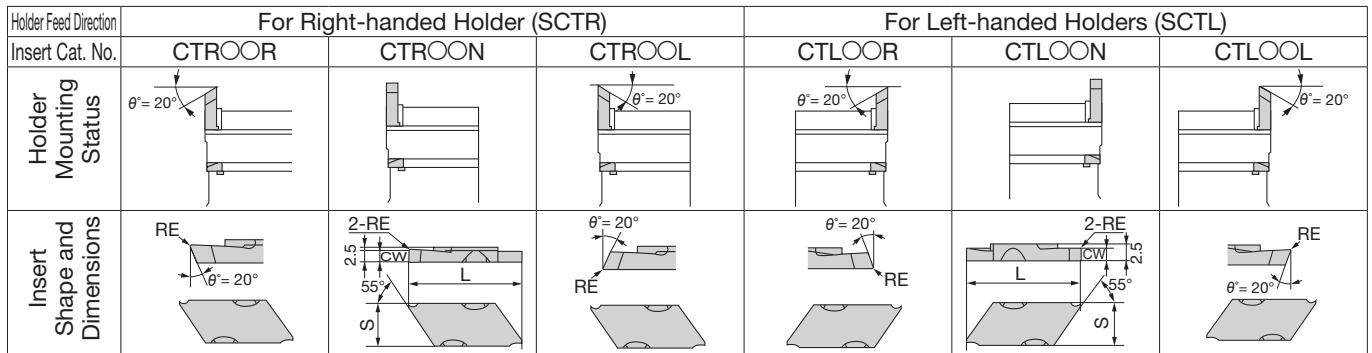

Insert (Right-handed) ( ■ Coated Carbide)

Dimensions (mm)

Cat. No.	AC1030U			AC530U			Max. Cut-off Dia.	Width of Cut CW	Corner Radius RE	Overall Length L	Thickness S	Chipbreaker	Applicable Holders
	R	N	L	R	N	L							
CTR 050505 R/N/L	●	●	●	●	●	●	5	0.5	0.05	19	7	Yes	SCT R1010 SCT R1212 SCT R1616
CTR 050500 R/N/L	●	●	●	●	●	●	5	0.5	0	19	7	Yes	
CTR 121005 R/N/L	●	●	●	●	●	●	12	1.0	0.05	19	7	Yes	
CTR 121505 R/N/L	●	●	●	●	●	●	12	1.5					
CTR 122005 R/N/L	●	●	●	●	●	●	12	2.0	0	19	7	Yes	
CTR 121000 R/N/L	●	●	●	●	●	●	12	1.0					
CTR 121500 R/N/L	●	●	●	●	●	●	12	1.5	0.05	23.1	8.3	Yes	
CTR 122000 R/N/L	●	●	●	●	●	●	12	2.0					
CTR 161005 R/N/L	●	●	●	●	●	●	16	1.0	0	23.1	8.3	Yes	
CTR 161505 R/N/L	●	●	●	●	●	●	16	1.5					
CTR 162005 R/N/L	●	●	●	●	●	●	16	2.0	0	23.1	8.3	Yes	
CTR 161000 R/N/L	●	●	●	●	●	●	16	1.0					
CTR 161500 R/N/L	●	●	●	●	●	●	16	1.5	0	23.1	8.3	No	
CTR 162000 R/N/L	●	●	●	●	●	●	16	2.0					
CTR 050500 R/N/L-NB	●	●	●	●	●	●	5	0.5	0	19	7	No	SCT R1010 SCT R1212 SCT R1616
CTR 121000 R/N/L-NB	●	●	●	●	●	●	12	1.0	0	19	7	No	
CTR 121500 R/N/L-NB	●	●	●	●	●	●	12	1.5					
CTR 122000 R/N/L-NB	●	●	●	●	●	●	12	2.0	0	23.1	8.3	No	
CTR 161000 R/N/L-NB	●	●	●	●	●	●	16	1.0					
CTR 161500 R/N/L-NB	●	●	●	●	●	●	16	1.5	0	23.1	8.3	No	
CTR 162000 R/N/L-NB	●	●	●	●	●	●	16	2.0					

Inserts (For Left-handed Holders) ( ■ Coated Carbide)

Dimensions (mm)

Cat. No.	AC1030U			AC530U			Max. Cut-off Dia.	Width of Cut CW	Corner Radius RE	Overall Length L	Thickness S	Chipbreaker	Applicable Holders
	R	N	L	R	N	L							
CTL 050505 R/N/L	●	●	●	●	●	●	5	0.5	0.05	19	7	Yes	SCT L1010 SCT L1212 SCT L1616
CTL 050500 R/N/L	●	●	●	●	●	●	5	0.5	0	19	7	Yes	
CTL 121005 R/N/L	●	●	●	●	●	●	12	1.0	0.05	19	7	Yes	
CTL 121505 R/N/L	●	●	●	●	●	●	12	1.5					
CTL 122005 R/N/L	●	●	●	●	●	●	12	2.0	0	19	7	Yes	
CTL 121000 R/N/L	●	●	●	●	●	●	12	1.0					
CTL 121500 R/N/L	●	●	●	●	●	●	12	1.5	0.05	23.1	8.3	Yes	
CTL 122000 R/N/L	●	●	●	●	●	●	12	2.0					
CTL 161005 R/N/L	●	●	●	●	●	●	16	1.0	0	23.1	8.3	Yes	
CTL 161505 R/N/L	●	●	●	●	●	●	16	1.5					
CTL 162005 R/N/L	●	●	●	●	●	●	16	2.0	0	23.1	8.3	Yes	
CTL 161000 R/N/L	●	●	●	●	●	●	16	1.0					
CTL 161500 R/N/L	●	●	●	●	●	●	16	1.5	0	23.1	8.3	No	
CTL 162000 R/N/L	●	●	●	●	●	●	16	2.0					
CTL 050500 R/N/L-NB	●	●	●	●	●	●	5	0.5	0	19	7	No	SCT L1010 SCT L1212 SCT L1616
CTL 121000 R/N/L-NB	●	●	●	●	●	●	12	1.0	0	19	7	No	
CTL 121500 R/N/L-NB	●	●	●	●	●	●	12	1.5					
CTL 122000 R/N/L-NB	●	●	●	●	●	●	12	2.0	0	23.1	8.3	No	
CTL 161000 R/N/L-NB	●	●	●	●	●	●	16	1.0					
CTL 161500 R/N/L-NB	●	●	●	●	●	●	16	1.5	0	23.1	8.3	No	
CTL 162000 R/N/L-NB	●	●	●	●	●	●	16	2.0					

Grooving Tools

Grooving

Cut-off

Threading

External

Face

Internal

Necking

CBN

# GNDM Type / GNDL Type



Grooving Tools

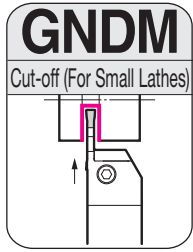

Fig 1

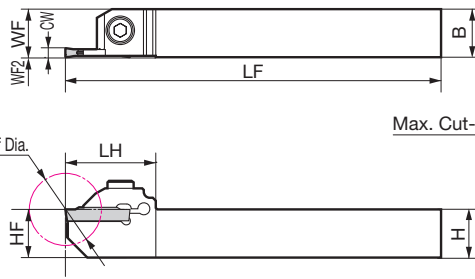

Fig 2

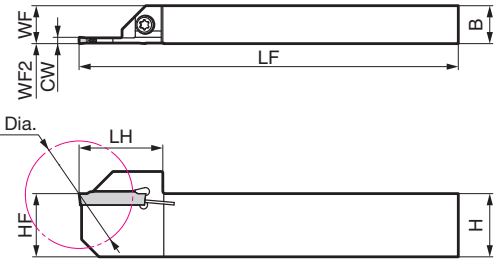

Figure shows right hand (R) tool.

## Holder

## Parts

Dimensions (mm)

Cat. No.	Stock		Height H	Width B	Overall Length LF	Cutting Edge Distance WF	Cutting Edge Height HF	Head LH	Offset WF2	Width of Cut CW	Max. Cut-off Dia.	Applicable Insert	Fig	Cap Screw		Wrench
	R	L												BFTX0414	N-m	
<b>GNDM R/L1616JX-1.2508</b>	●	●	16	16	120	(16)	16	26	0	<b>1.25</b>	<b>16</b>	GCM N125005-GF	1	BX0515	<b>4.0</b>	LH040
<b>GNDM R/L1616JX-1.510</b>	●	●	16	16	120	(16)	16	26	0	<b>1.50</b>	<b>20</b>	GCM N150005-GF	1			
<b>GNDM R/L1616JX-212</b>	●	●	16	16	120	(16)	16	30	0	<b>2.00</b>	<b>24</b>	GC □ □20○-□□	1			
<b>GNDM R/L1616JX-312</b>	●	●	16	16	120	(16)	16	30	0	<b>3.00</b>	<b>24</b>	GC □ □30○-□□	1	BFTX0414	<b>3.0</b>	LT15-10
<b>GNDM R/L2012JX-217</b>	●	●	20	12	120	(12)	20	26.5	0	<b>2.00</b>	<b>34</b>	GC □ □20○-□□	2			
<b>GNDM R/L2012JX-317</b>	●	●	20	12	120	(12)	20	26.5	0	<b>3.00</b>	<b>34</b>	GC □ □30○-□□	2			

Combine the insert with a holder such that the width of cut (CW) matches.  
Refer to F75 for applicable inserts.



Face Internal

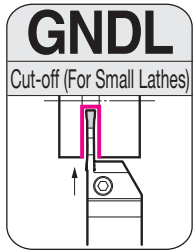

Fig 1

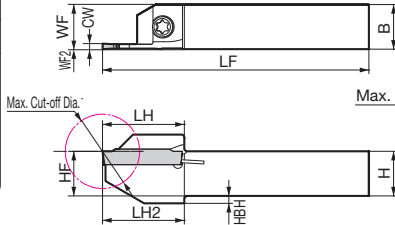

Fig 2

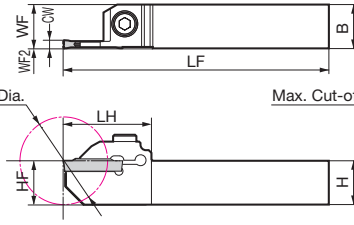

Fig 3

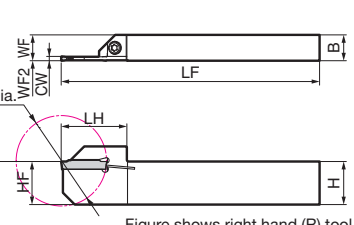

Figure shows right hand (R) tool.

## Holder

## Parts

Dimensions (mm)

Cat. No.	Stock		Height H	Width B	Overall Length LF	Cutting Edge Distance WF	Cutting Edge Height HF	Step HBH	Head LH	Head LH2	Offset WF2	Width of Cut CW	Max. Cut-off Dia.	Applicable Insert	Fig	Flat Screw / Cap Screw		Wrench
	R	L														BFTX0412N	N-m	
<b>GNDL R/L1010JX-1.2510</b>	●	●	10	10	120	(10)	10	2.0	18	18.3	0	<b>1.25</b>	<b>20</b>	GCM N125005-GF	1	BFTX0412N	<b>3.0</b>	LT15-10
<b>GNDL R/L1010JX-1.510</b>	●	●	10	10	120	(10)	10	2.0	18	18.3	0	<b>1.50</b>	<b>20</b>	GCM N150005-GF	1			
<b>GNDL R/L1010JX-210</b>	●	●	10	10	120	(10)	10	2.0	22	22.3	0	<b>2.00</b>	<b>20</b>	GC □ □20○-□□	1			
<b>GNDL R/L1010JX-310</b>	●	●	10	10	120	(10)	10	2.0	22	22.3	0	<b>3.00</b>	<b>20</b>	GC □ □30○-□□	1	BFTX0412N	<b>3.0</b>	LT15-10
<b>GNDL R/L1212JX-1.2512</b>	●	●	12	12	120	(12)	12	2.0	19	19.3	0	<b>1.25</b>	<b>24</b>	GCM N125005-GF	1			
<b>GNDL R/L1212JX-1.512</b>	●	●	12	12	120	(12)	12	2.0	19	19.3	0	<b>1.50</b>	<b>24</b>	GCM N150005-GF	1			
<b>GNDL R/L1212JX-212.5</b>	●	●	12	12	120	(12)	12	2.0	22	22.3	0	<b>2.00</b>	<b>25</b>	GC □ □20○-□□	1	BFTX0412N	<b>3.0</b>	LT15-10
<b>GNDL R/L1212JX-312.5</b>	●	●	12	12	120	(12)	12	2.0	22	22.3	0	<b>3.00</b>	<b>25</b>	GC □ □30○-□□	1			
<b>GNDL R/L1616JX-1.2512.5</b>	●	●	16	16	120	(16)	16	—	28	—	0	<b>1.25</b>	<b>20</b>	GCM N125005-GF	2			
<b>GNDL R/L1616JX-1.512.5</b>	●	●	16	16	120	(16)	16	—	28	—	0	<b>1.50</b>	<b>25</b>	GCM N150005-GF	2	BX0515	<b>4.0</b>	LH040
<b>GNDL R/L1616JX-216</b>	●	●	16	16	120	(16)	16	—	32	—	0	<b>2.00</b>	<b>32</b>	GC □ □20○-□□	2			
<b>GNDL R/L1616JX-316</b>	●	●	16	16	120	(16)	16	—	32	—	0	<b>3.00</b>	<b>32</b>	GC □ □30○-□□	2			
<b>GNDL R/L2012JX-221</b>	●	●	20	12	120	(12)	20	—	30.5	—	0	<b>2.00</b>	<b>42</b>	GC □ □20○-□□	3	BFTX0414	<b>3.0</b>	LT15-10
<b>GNDL R/L2012JX-321</b>	●	●	20	12	120	(12)	20	—	30.5	—	0	<b>3.00</b>	<b>42</b>	GC □ □30○-□□	3			

Combine the insert with a holder such that the width of cut (CW) matches.  
Refer to F75 for applicable inserts.

# GNDM Type / GNDL Type



GNDM Type (For Small Lathes)/GNDL Type (For Small Lathes) Inserts ( ■ Coated Carbide/ ■ Cermet/  Cemented Carbide)

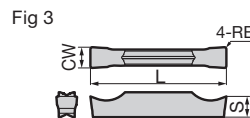
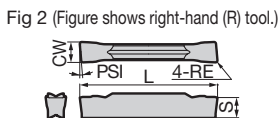
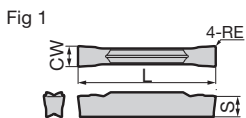

## Grooving / Traverse Cutting

Dimensions (mm)

Cat. No.	Material										Width of Cut CW		Corner Radius RE	Overall Length L	Thickness S	Pcs/Pack	Fig
	AC8025P	AC8035P	AC830P	AC425K	AC5015S	AC5025S	AC520U	AC530U	T2500A	Width of Cut	Tolerance						
	●	●	●	●	●	●	●	●	●	RE	L	S					
GCM N3002-MG N3004-MG	●	●	●	●	●	●	●	●	●	●	3.0	±0.03	0.2	21.1	3.8	5	1
GCM N2002-ML	—	—	—	—	—	—	—	—	—	—	2.0	±0.03	0.2	21.1	3.6	—	1
GCM N3002-ML N3004-ML	●	●	●	●	●	●	●	●	●	●	3.0	±0.03	0.2	21.1	3.8	5	1
	●	●	●	●	●	●	●	●	●	●	3.0	±0.03	0.4	21.1	3.8	—	1

## Cut-off (Handed Edge)

Dimensions (mm)

Cat. No.	Material										Lead Angle PSI	Width of Cut CW		Corner Radius RE	Overall Length L	Thickness S	Pcs/Pack	Fig
	AC8025P	AC8035P	AC830P	AC425K	AC5015S	AC5025S	AC520U	AC530U	AC1030U	Width of Cut		Tolerance						
	●	●	●	●	●	●	●	●	●	RE		L	S					
GCM R2002-CG-05 L2002-CG-05	●	●	●	●	●	●	●	●	●	●	5°	2.0	±0.03	0.2	21.1	3.6	2	
GCM R3002-CG-05 L3002-CG-05	●	●	●	●	●	●	●	●	●	●	5°	3.0	±0.03	0.2	21.3	3.8	5	
GCM R20003-CF-10 L20003-CF-10	—	—	—	—	—	—	—	—	—	—	10°	2.0	±0.08	0.03	22.4	3.6	2	
GCM R30003-CF-10 L30003-CF-10	—	—	—	—	—	—	—	—	—	—	10°	3.0	±0.08	0.03	22.4	3.8	2	
GCM R20003-CF-15 L20003-CF-15	—	—	—	—	—	—	—	—	—	—	15°	2.0	±0.08	0.03	22.4	3.6	5	
GCM R30003-CF-15 L30003-CF-15	—	—	—	—	—	—	—	—	—	—	15°	3.0	±0.08	0.03	22.4	3.8	2	
	—	—	—	—	—	—	—	—	—	—	15°	3.0	±0.08	0.03	22.4	3.8	2	

GCMR: Right Handed, GCML: Left Handed

## Grooving / Cut-off

Dimensions (mm)

Cat. No.	Material										Width of Cut CW		Corner Radius RE	Overall Length L	Thickness S	Pcs/Pack	Fig
	AC8025P	AC8035P	AC830P	AC425K	AC5015S	AC5025S	AC520U	AC530U	T2500A	Width of Cut	Tolerance						
	●	●	●	●	●	●	●	●	●	RE	L	S					
GCM N2002-GG	—	●	●	—	—	—	—	—	—	—	2.0	±0.03	0.2	21.1	3.6	5	1
GCM N3002-GG N3004-GG	—	●	●	—	—	—	—	—	—	—	3.0	±0.03	0.4	21.1	3.8	—	1
GCM N2002-GL N2004-GL	—	●	●	—	—	—	—	—	—	—	2.0	±0.03	0.2	21.1	3.6	5	1
GCM N3002-GL N3004-GL	—	●	●	—	—	—	—	—	—	—	3.0	±0.03	0.2	21.1	3.8	—	1
	—	●	●	—	—	—	—	—	—	—	3.0	±0.03	0.4	21.1	3.8	—	1
GCM N125005-GF	—	—	—	—	—	—	—	—	—	—	1.25	±0.03	0.05	17.4	3.2	—	1
GCM N150005-GF	—	—	—	—	—	—	—	—	—	—	1.5	±0.03	0.05	17.4	3.7	—	1
GCM N2002-GF N2004-GF	—	—	—	—	—	—	—	—	—	—	2.0	±0.03	0.2	21.1	3.6	5	1
	—	—	—	—	—	—	—	—	—	—	2.0	±0.03	0.4	21.1	3.6	—	1
GCM N3002-GF N3004-GF	—	●	●	—	—	—	—	—	—	—	3.0	±0.03	0.2	21.1	3.8	—	1
	—	●	●	—	—	—	—	—	—	—	3.0	±0.03	0.4	21.1	3.8	—	1

## Non-Ferrous Metals

Dimensions (mm)

Cat. No.	H10	Material										Width of Cut CW		Corner Radius RE	Overall Length L	Thickness S	Pcs/Pack	Fig
		AC8025P	AC8035P	AC830P	AC425K	AC5015S	AC5025S	AC520U	AC530U	AC1030U	Width of Cut	Tolerance						
		●	●	●	●	●	●	●	●	●	RE	L	S					
GCG N2002-GA N3002-GA	●	—	—	—	—	—	—	—	—	—	2.0	±0.025	0.2	21.1	3.6	5	3	
	●	—	—	—	—	—	—	—	—	—	3.0	±0.025	0.2	21.1	3.8	—	3	

## Part Number Suffix Code (Chipbreakers)

Type	Symbol	Applications	Type	Symbol	Applications
Grooving/ Traverse Cutting	MG	Multi-functional / General-purpose	Cut-off (Handed Edge) For Non-Ferrous Metals	CG	Cut-off / General-purpose
	ML	Multi-functional / Low-feed		CF	Cut-off / Low-resistance
Grooving / Cut-off	GG	Grooving / General-purpose	Non-Ferrous Metals / General-purpose	GA	Non-Ferrous Metals / General-purpose
	GL	Grooving / Low Feed			
	GF	Grooving / Low-resistance			

Chipbreaker Selection **F13** Important Notes **F22** Recommended Cutting Conditions **F19**

Select holders and inserts with matching width of cut (CW). Not usable with GNDIS type holders.

● mark: Standard stocked item (new product/expanded item)

# GNDM-J Type / GNDL-J Type



Grooving Tools

F

Grooving

Cut-off

Threading

External

Face

Internal

Necking

CBN

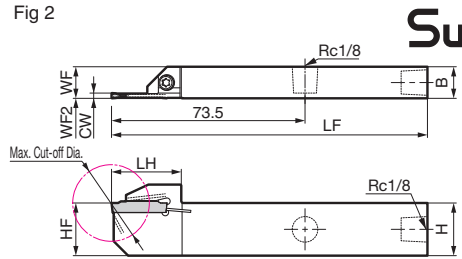
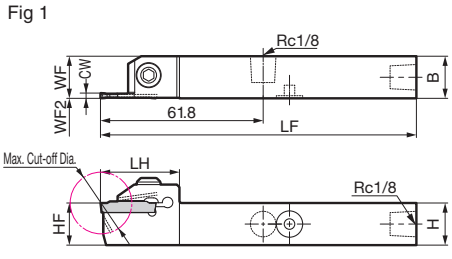
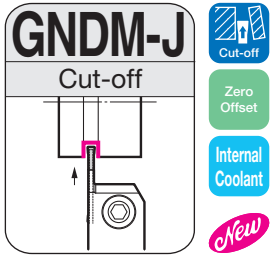

Figure shows right hand (R) tool.

## Holder

Dimensions (mm)

Cat. No.	Stock		Height	Width	Overall Length	Cutting Edge Distance	Cutting Edge Height	Head	Offset	Width of Cut	Max. Cut-off Dia.	Applicable Insert	Fig	Flat Screw / Cap Screw	N-m	Plug	Top Hex Wrench	Bottom Hex Wrench
	R	L																
<b>GNDM R/L1616JX-212J</b> <i>New</i>	●	●	16	16	120 (16)	16	30.0	0	<b>2.0</b>	<b>24</b>	GC □ 2000-□□	1	CP-M5-20-1	<b>5.0</b>	XP02	LH040	LH025	
<b>GNDM R/L1616JX-312J</b> <i>New</i>	●	●	16	16	120 (16)	16	30.0	0	<b>3.0</b>	<b>24</b>	GC □ 3000-□□	1	CP-M5-20-1	<b>5.0</b>	XP02	LH040	LH025	
<b>GNDM R/L2012JX-217J</b> <i>New</i>	●	●	20	12	120 (12)	20	26.5	0	<b>2.0</b>	<b>34</b>	GC □ 2000-□□	2	BFTX0414	<b>3.0</b>	XP02	LT15-10	—	
<b>GNDM R/L2012JX-317J</b> <i>New</i>	●	●	20	12	120 (12)	20	26.5	0	<b>3.0</b>	<b>34</b>	GC □ 3000-□□	2	BFTX0414	<b>3.0</b>	XP02	LT15-10	—	

Match inserts and holders with identical widths of cut (CW). Refer to F77 for applicable inserts.

## Parts

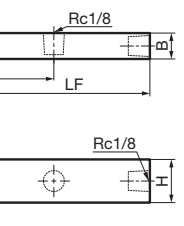
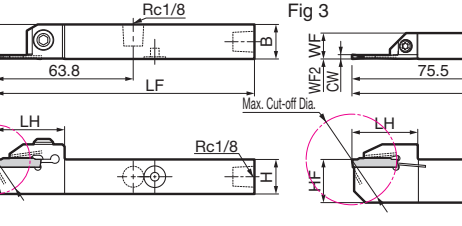
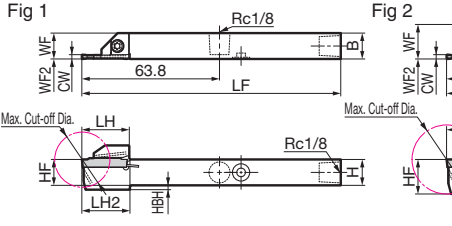
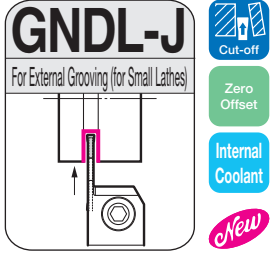
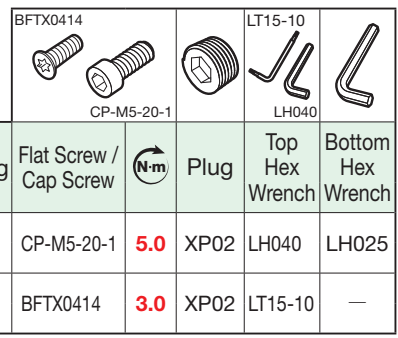

## Holder

Dimensions (mm)

Cat. No.	Stock		Height	Width	Overall Length	Cutting Edge Distance	Cutting Edge Height	Step	Head	Head	Offset	Width of Cut	Max. Cut-off Dia.	Applicable Insert	Fig	Flat Screw / Cap Screw	N-m	Plug	Top Hex Wrench	Bottom Hex Wrench
	R	L																		
<b>GNDL R/L1212JX-212.5J</b> <i>New</i>	●	●	12	12	120 (12)	12	2.0	22.0	22.3	0	<b>2.0</b>	<b>25</b>	GC □ 2000-□□	1	BFTX0415T8R	<b>1.5</b>	XP02	LT08-06	←	
<b>GNDL R/L1212JX-312.5J</b> <i>New</i>	●	●	12	12	120 (12)	12	2.0	22.0	22.3	0	<b>3.0</b>	<b>25</b>	GC □ 3000-□□	1	BFTX0415T8R	<b>1.5</b>	XP02	LT08-06	←	
<b>GNDL R/L1616JX-216J</b> <i>New</i>	●	●	16	16	120 (16)	16	—	32.0	—	0	<b>2.0</b>	<b>32</b>	GC □ 2000-□□	2	CP-M5-20-1	<b>5.0</b>	XP02	LH040	LH025	
<b>GNDL R/L1616JX-316J</b> <i>New</i>	●	●	16	16	120 (16)	16	—	32.0	—	0	<b>3.0</b>	<b>32</b>	GC □ 3000-□□	2	CP-M5-20-1	<b>5.0</b>	XP02	LH040	LH025	
<b>GNDL R/L2012JX-221J</b> <i>New</i>	●	●	20	12	120 (12)	20	—	30.5	—	0	<b>2.0</b>	<b>42</b>	GC □ 2000-□□	3	BFTX0414	<b>3.0</b>	XP02	LT15-10	—	
<b>GNDL R/L2012JX-321J</b> <i>New</i>	●	●	20	12	120 (12)	20	—	30.5	—	0	<b>3.0</b>	<b>42</b>	GC □ 3000-□□	3	BFTX0414	<b>3.0</b>	XP02	LT15-10	—	

Match inserts and holders with identical widths of cut (CW). Refer to F77 for applicable inserts.

## Parts

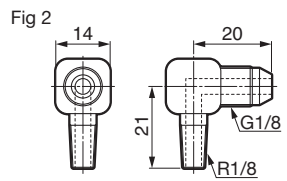
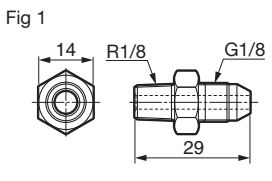
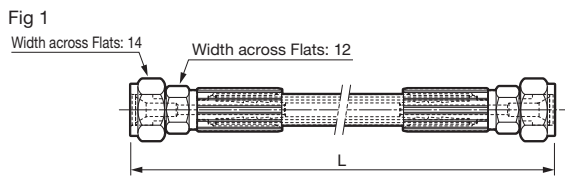
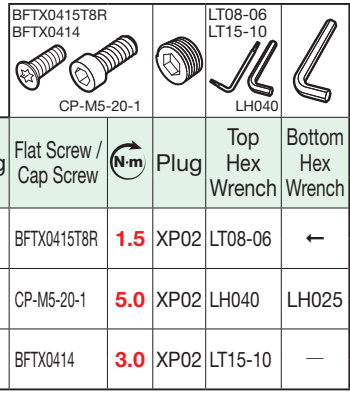

## Parts (Hose)

Dimensions (mm)

Cat. No.	Stock	L	Screw Standard	Screw Standard	Fig
<b>J-HOSE-G1/8-G1/8-200</b>	●	200	G1/8	G1/8	1
<b>J-HOSE-G1/8-G1/8-300</b>	●	300	G1/8	G1/8	1

Hoses are sold separately.

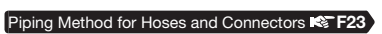

## Parts (Connector)

Dimensions (mm)

Cat. No.	Stock	Screw Standard	Screw Standard	Fig
<b>J-G1/8-R1/8-00</b>	●	G1/8	R1/8	1
<b>J-G1/8-R1/8-90</b>	●	G1/8	R1/8	2

Connectors are sold separately.

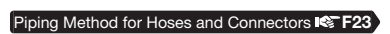



# GNDM-J Type / GNDL-J Type



GNDM-J Type (For Small Lathes)/GNDL-J Type (For Small Lathes) Inserts (      Coated Carbide/      Cermet/  Cemented Carbide)

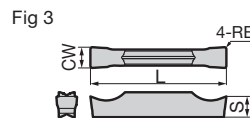
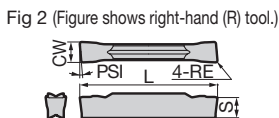
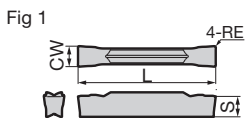

### Grooving / Traverse Cutting

Dimensions (mm)

Cat. No.	Material										Width of Cut CW		Corner Radius RE	Overall Length L	Thickness S	Pcs/Pack	Fig
	AC8025P	AC8035P	AC830P	AC425K	AC5015S	AC5025S	AC520U	AC530U	T2500A	Width of Cut	Tolerance						
	●	●	●	●	●	●	●	●	●	RE	L						
GCM N3002-MG N3004-MG	●	●	●	●	●	●	●	●	●	●	3.0	±0.03	0.2	21.1	3.8	5	1
GCM N2002-ML GCM N3002-ML N3004-ML	●	●	●	●	●	●	●	●	●	●	2.0	±0.03	0.2	21.1	3.6	5	1
	●	●	●	●	●	●	●	●	●	●	3.0	±0.03	0.2	21.1	3.8	5	1
	●	●	●	●	●	●	●	●	●	●	3.0	±0.03	0.4	21.1	3.8	5	1

### Cut-off (Handed Edge)

Dimensions (mm)

Cat. No.	Material										Lead Angle PSI	Width of Cut CW		Corner Radius RE	Overall Length L	Thickness S	Pcs/Pack	Fig
	AC8025P	AC8035P	AC830P	AC425K	AC5015S	AC5025S	AC520U	AC530U	AC1030U	Width of Cut		Tolerance						
	●	●	●	●	●	●	●	●	●	Width of Cut		Tolerance						
GCM R2002-CG-05 L2002-CG-05	●	●	●	●	●	●	●	●	●	●	5°	2.0	±0.03	0.2	21.1	3.6	5	2
GCM R3002-CG-05 L3002-CG-05	●	●	●	●	●	●	●	●	●	●	5°	3.0	±0.03	0.2	21.3	3.8	5	2
GCM R20003-CF-10 L20003-CF-10	●	●	●	●	●	●	●	●	●	●	10°	2.0	±0.08	0.03	22.4	3.6	5	2
GCM R30003-CF-10 L30003-CF-10	●	●	●	●	●	●	●	●	●	●	10°	3.0	±0.08	0.03	22.4	3.8	5	2
GCM R20003-CF-15 L20003-CF-15	●	●	●	●	●	●	●	●	●	●	15°	2.0	±0.08	0.03	22.4	3.6	5	2
GCM R30003-CF-15 L30003-CF-15	●	●	●	●	●	●	●	●	●	●	15°	3.0	±0.08	0.03	22.4	3.8	5	2
	●	●	●	●	●	●	●	●	●	●	15°	3.0	±0.08	0.03	22.4	3.8	5	2

GCMR: Right Handed, GCML: Left Handed

### Grooving / Cut-off

Dimensions (mm)

Cat. No.	Material										Width of Cut CW		Corner Radius RE	Overall Length L	Thickness S	Pcs/Pack	Fig
	AC8025P	AC8035P	AC830P	AC425K	AC5015S	AC5025S	AC520U	AC530U	T2500A	Width of Cut	Tolerance						
	●	●	●	●	●	●	●	●	●	Width of Cut	Tolerance						
GCM N2002-GG GCM N3002-GG N3004-GG	●	●	●	●	●	●	●	●	●	●	2.0	±0.03	0.2	21.1	3.6	5	1
GCM N2002-GL N2004-GL	●	●	●	●	●	●	●	●	●	●	2.0	±0.03	0.2	21.1	3.6	5	1
GCM N3002-GL N3004-GL	●	●	●	●	●	●	●	●	●	●	3.0	±0.03	0.2	21.1	3.8	5	1
GCM N2002-GF N2004-GF	●	●	●	●	●	●	●	●	●	●	2.0	±0.03	0.2	21.1	3.6	5	1
GCM N3002-GF N3004-GF	●	●	●	●	●	●	●	●	●	●	3.0	±0.03	0.2	21.1	3.8	5	1
	●	●	●	●	●	●	●	●	●	●	3.0	±0.03	0.4	21.1	3.8	5	1

### Non-Ferrous Metals

Dimensions (mm)

Cat. No.	H10	Material										Width of Cut CW		Corner Radius RE	Overall Length L	Thickness S	Pcs/Pack	Fig
		AC8025P	AC8035P	AC830P	AC425K	AC5015S	AC5025S	AC520U	AC530U	T2500A	Width of Cut	Tolerance						
		●	●	●	●	●	●	●	●	●	Width of Cut	Tolerance						
GCG N2002-GA N3002-GA	●	●	●	●	●	●	●	●	●	●	2.0	±0.025	0.2	21.1	3.6	5	3	
	●	●	●	●	●	●	●	●	●	●	3.0	±0.025	0.2	21.1	3.8	5	3	

### Part Number Suffix Code (Chipbreakers)

Type	Symbol	Applications	Type	Symbol	Applications
Grooving/ Traverse Cutting	MG	Multi-functional / General-purpose	Cut-off (Handed Edge) For Non-Ferrous Metals	CG	Cut-off / General-purpose
	ML	Multi-functional / Low-feed		CF	Cut-off / Low-resistance
Grooving / Cut-off	GG	Grooving / General-purpose	For Non-Ferrous Metals	GA	Non-Ferrous Metals / General-purpose
	GL	Grooving / Low Feed			
	GF	Grooving / Low-resistance			

Chipbreaker Selection **F13** Important Notes **F22** Recommended Cutting Conditions **F19**

Select holders and inserts with matching width of cut (CW). Not usable with GNDIS type holders.

● mark: Standard stocked item (new product/expanded item)

Grooving Tools  
Grooving  
Cut-off  
Threading  
External  
Face  
Internal  
Necking  
CBN

# GNDS Type



\* For traverse cutting (groove expansion), use a multifunctional insert for profiling.

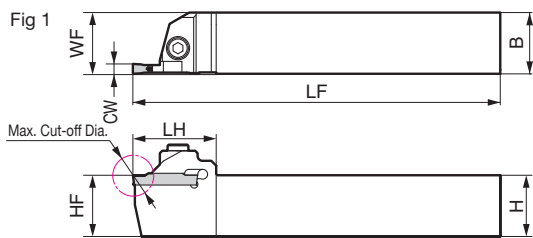
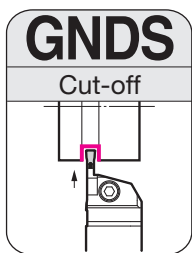

Figure shows right hand (R) tool.

## Holder

## Parts

Dimensions (mm)

Cat. No.	Stock		Height H	Width B	Overall Length LF	Cutting Edge Distance WF	Cutting Edge Height HF	Head LH	Width of Cut CW	Max. Cut-off Dia.	Applicable Insert	Fig	Cap Screw		Wrench
	R	L											N·m	Icon	
GNDS R/L2020K-206	●	●	20	20	125	20	20	30	2.0	12	GC □ □20○○-□□	1	BX0520	5.0	LH040
GNDS R/L2020K-306	●	●	20	20	125	20	20	30	3.0	12	GC □ □30○○-□□	1			
GNDS R/L2020K-410	●	●	20	20	125	20	20	34	4.0	20	GC □ □40○○-□□	1			
GNDS R/L2020K-510	●	●	20	20	125	20	20	34	5.0	20	GC □ N50○○-□□	1			
GNDS R/L2020K-610	●	●	20	20	125	20	20	34	6.0	20	GC □ N60○○-□□	1			
GNDS R/L2525M-206	●	●	25	25	150	25	25	30	2.0	12	GC □ □20○○-□□	1	BX0520	5.0	LH040
GNDS R/L2525M-306	●	●	25	25	150	25	25	30	3.0	12	GC □ □30○○-□□	1			
GNDS R/L2525M-410	●	●	25	25	150	25	25	34	4.0	20	GC □ □40○○-□□	1			
GNDS R/L2525M-510	●	●	25	25	150	25	25	34	5.0	20	GC □ N50○○-□□	1			
GNDS R/L2525M-610	●	●	25	25	150	25	25	34	6.0	20	GC □ N60○○-□□	1			

Combine the insert with a holder such that the width of cut (CW) matches. Refer to F79 for applicable inserts.

Grooving Tools

Grooving

Cut-off

Threading

External

Face

Internal

Necking

CBN



## GNDS Type Inserts

(      Coated Carbide/      Cermet/  Cemented Carbide)

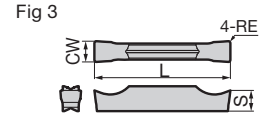
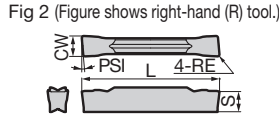
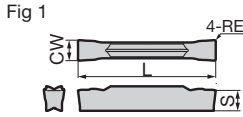

### Grooving / Traverse Cutting

Dimensions (mm)

Cat. No.	Material								Width of Cut CW			Corner Radius RE	Overall Length L	Thickness S	Pcs/Pack	Fig		
	AC8025P	AC8035P	AC830P	AC425K	AC5015S	AC5025S	AC520U	AC530U	Width of Cut	Tolerance	RE						L	S
	T2500A	Width of Cut	Tolerance	RE	L	S												
GCM N3002-MG	●	●	●	●	●	●	●	●	3.0	±0.03	0.2	21.1	3.8	1	1			
N3004-MG	●	●	●	●	●	●	●	●	3.0	±0.03	0.4	21.1	3.8	1	1			
GCM N4002-MG	●	●	●	●	●	●	●	●	4.0	±0.03	0.2	26.4	4.0	1	1			
N4004-MG	●	●	●	●	●	●	●	●	4.0	±0.03	0.4	26.4	4.0	1	1			
N4008-MG	●	●	●	●	●	●	●	●	4.0	±0.03	0.8	26.4	4.0	5	1			
GCM N5004-MG	●	●	●	●	●	●	●	●	5.0	±0.03	0.4	26.4	4.1	1	1			
N5008-MG	●	●	●	●	●	●	●	●	5.0	±0.03	0.8	26.4	4.1	1	1			
GCM N6004-MG	●	●	●	●	●	●	●	●	6.0	±0.03	0.4	26.4	4.5	1	1			
N6008-MG	●	●	●	●	●	●	●	●	6.0	±0.03	0.8	26.4	4.5	1	1			
GCM N2002-ML	●	●	●	●	●	●	●	●	2.0	±0.03	0.2	21.1	3.6	1	1			
GCM N3002-ML	●	●	●	●	●	●	●	●	3.0	±0.03	0.2	21.1	3.8	1	1			
N3004-ML	●	●	●	●	●	●	●	●	3.0	±0.03	0.4	21.1	3.8	1	1			
GCM N4002-ML	●	●	●	●	●	●	●	●	4.0	±0.03	0.2	26.4	4.0	1	1			
N4004-ML	●	●	●	●	●	●	●	●	4.0	±0.03	0.4	26.4	4.0	1	1			
N4008-ML	●	●	●	●	●	●	●	●	4.0	±0.03	0.8	26.4	4.0	5	1			
GCM N5004-ML	●	●	●	●	●	●	●	●	5.0	±0.03	0.4	26.4	4.1	1	1			
N5008-ML	●	●	●	●	●	●	●	●	5.0	±0.03	0.8	26.4	4.1	1	1			
GCM N6004-ML	●	●	●	●	●	●	●	●	6.0	±0.03	0.4	26.4	4.5	1	1			
N6008-ML	●	●	●	●	●	●	●	●	6.0	±0.03	0.8	26.4	4.5	1	1			

### Cut-off (Handed Edge)

Dimensions (mm)

Cat. No.	Material								Lead Angle PSI	Width of Cut CW			Corner Radius RE	Overall Length L	Thickness S	Pcs/Pack	Fig		
	AC8025P	AC8035P	AC830P	AC425K	AC5015S	AC5025S	AC520U	AC530U		Width of Cut	Tolerance	RE						L	S
	AC1030U	Width of Cut	Tolerance	RE	L	S													
GCM R2002-CG-05	●	●	●	●	●	●	●	●	5°	2.0	±0.03	0.2	21.1	3.6	2	2			
L2002-CG-05	●	●	●	●	●	●	●	●	5°	2.0	±0.03	0.2	21.1	3.6	2	2			
GCM R3002-CG-05	●	●	●	●	●	●	●	●	5°	3.0	±0.03	0.2	21.3	3.8	5	2			
L3002-CG-05	●	●	●	●	●	●	●	●	5°	3.0	±0.03	0.2	21.3	3.8	2	2			
GCM R4002-CG-05	●	●	●	●	●	●	●	●	5°	4.0	±0.04	0.2	26.7	4.0	2	2			
L4002-CG-05	●	●	●	●	●	●	●	●	5°	4.0	±0.04	0.2	26.7	4.0	2	2			
GCM R20003-CF-10	●	●	●	●	●	●	●	●	10°	2.0	±0.08	0.03	22.4	3.6	2	2			
L20003-CF-10	●	●	●	●	●	●	●	●	10°	2.0	±0.08	0.03	22.4	3.6	2	2			
GCM R30003-CF-10	●	●	●	●	●	●	●	●	10°	3.0	±0.08	0.03	22.4	3.8	5	2			
L30003-CF-10	●	●	●	●	●	●	●	●	10°	3.0	±0.08	0.03	22.4	3.8	2	2			
GCM R20003-CF-15	●	●	●	●	●	●	●	●	15°	2.0	±0.08	0.03	22.4	3.6	2	2			
L20003-CF-15	●	●	●	●	●	●	●	●	15°	2.0	±0.08	0.03	22.4	3.6	2	2			
GCM R30003-CF-15	●	●	●	●	●	●	●	●	15°	3.0	±0.08	0.03	22.4	3.8	2	2			
L30003-CF-15	●	●	●	●	●	●	●	●	15°	3.0	±0.08	0.03	22.4	3.8	2	2			

GCMR: Right Handed, GCML: Left Handed

### Grooving / Cut-off

Dimensions (mm)

Cat. No.	Material								Width of Cut CW			Corner Radius RE	Overall Length L	Thickness S	Pcs/Pack	Fig		
	AC8025P	AC8035P	AC830P	AC425K	AC5015S	AC5025S	AC520U	AC530U	Width of Cut	Tolerance	RE						L	S
	T2500A	Width of Cut	Tolerance	RE	L	S												
GCM N2002-GG	●	●	●	●	●	●	●	●	2.0	±0.03	0.2	21.1	3.6	1	1			
GCM N3002-GG	●	●	●	●	●	●	●	●	3.0	±0.03	0.2	21.1	3.8	1	1			
N3004-GG	●	●	●	●	●	●	●	●	3.0	±0.03	0.4	21.1	3.8	1	1			
GCM N4002-GG	●	●	●	●	●	●	●	●	4.0	±0.03	0.2	26.4	4.0	1	1			
N4004-GG	●	●	●	●	●	●	●	●	4.0	±0.03	0.4	26.4	4.0	5	1			
GCM N5002-GG	●	●	●	●	●	●	●	●	5.0	±0.03	0.2	26.4	4.1	1	1			
N5004-GG	●	●	●	●	●	●	●	●	5.0	±0.03	0.4	26.4	4.1	1	1			
GCM N6002-GG	●	●	●	●	●	●	●	●	6.0	±0.03	0.2	26.4	4.5	1	1			
N6004-GG	●	●	●	●	●	●	●	●	6.0	±0.03	0.4	26.4	4.5	1	1			
GCM N2002-GL	●	●	●	●	●	●	●	●	2.0	±0.03	0.2	21.1	3.6	1	1			
N2004-GL	●	●	●	●	●	●	●	●	2.0	±0.03	0.4	21.1	3.6	1	1			
GCM N3002-GL	●	●	●	●	●	●	●	●	3.0	±0.03	0.2	21.1	3.8	1	1			
N3004-GL	●	●	●	●	●	●	●	●	3.0	±0.03	0.4	21.1	3.8	1	1			
GCM N4002-GL	●	●	●	●	●	●	●	●	4.0	±0.03	0.2	26.4	4.0	1	1			
N4004-GL	●	●	●	●	●	●	●	●	4.0	±0.03	0.4	26.4	4.0	5	1			
GCM N5002-GL	●	●	●	●	●	●	●	●	5.0	±0.03	0.2	26.4	4.1	1	1			
N5004-GL	●	●	●	●	●	●	●	●	5.0	±0.03	0.4	26.4	4.1	1	1			
GCM N6002-GL	●	●	●	●	●	●	●	●	6.0	±0.03	0.2	26.4	4.5	1	1			
N6004-GL	●	●	●	●	●	●	●	●	6.0	±0.03	0.4	26.4	4.5	1	1			
GCM N2002-GF	●	●	●	●	●	●	●	●	2.0	±0.03	0.2	21.1	3.6	1	1			
N2004-GF	●	●	●	●	●	●	●	●	2.0	±0.03	0.4	21.1	3.6	1	1			
GCM N3002-GF	●	●	●	●	●	●	●	●	3.0	±0.03	0.2	21.1	3.8	1	1			
N3004-GF	●	●	●	●	●	●	●	●	3.0	±0.03	0.4	21.1	3.8	1	1			
GCM N4002-GF	●	●	●	●	●	●	●	●	4.0	±0.03	0.2	26.4	4.0	1	1			
N4004-GF	●	●	●	●	●	●	●	●	4.0	±0.03	0.4	26.4	4.0	5	1			
GCM N5002-GF	●	●	●	●	●	●	●	●	5.0	±0.03	0.2	26.4	4.1	1	1			
N5004-GF	●	●	●	●	●	●	●	●	5.0	±0.03	0.4	26.4	4.1	1	1			
GCM N6002-GF	●	●	●	●	●	●	●	●	6.0	±0.03	0.2	26.4	4.5	1	1			
N6004-GF	●	●	●	●	●	●	●	●	6.0	±0.03	0.4	26.4	4.5	1	1			

### Non-Ferrous Metals

Dimensions (mm)

Cat. No.	H10	Material								Width of Cut CW			Corner Radius RE	Overall Length L	Thickness S	Pcs/Pack	Fig		
		AC8025P	AC8035P	AC830P	AC425K	AC5015S	AC5025S	AC520U	AC530U	Width of Cut	Tolerance	RE						L	S
		Width of Cut	Tolerance	RE	L	S													
GCG N2002-GA	●	●	●	●	●	●	●	●	2.0	±0.025	0.2	21.1	3.6	3	3				
N3002-GA	●	●	●	●	●	●	●	●	3.0	±0.025	0.2	21.1	3.8	3	3				
GCG N4004-GA	●	●	●	●	●	●	●	●	4.0	±0.025	0.4	26.4	4.0	5	3				
N5004-GA	●	●	●	●	●	●	●	●	5.0	±0.025	0.4	26.4	4.1	3	3				
N6004-GA	●	●	●	●	●	●	●	●	6.0	±0.025	0.4	26.4	4.5	3	3				

### Part Number Suffix Code (Chipbreakers)

Type	Symbol	Applications	Type	Symbol	Applications
Grooving/ Traverse Cutting	MG	Multi-functional / General-purpose	Cut-off (Handed Edge)	CG	Cut-off / General-purpose
	ML	Multi-functional / Low-feed		CF	Cut-off / Low-resistance
Grooving / Cut-off	GG	Grooving / General-purpose	For Non-Ferrous Metals	GA	Non-Ferrous Metals / General-purpose
	GL	Grooving / Low Feed			
	GF	Grooving / Low-resistance			

Chipbreaker Selection **F13** Important Notes **F22** Recommended Cutting Conditions **F19**

Select holders and inserts with matching width of cut (CW). Not usable with GNDS type holders.

● mark: Standard stocked item (new product/expanded item)

# GNDM Type

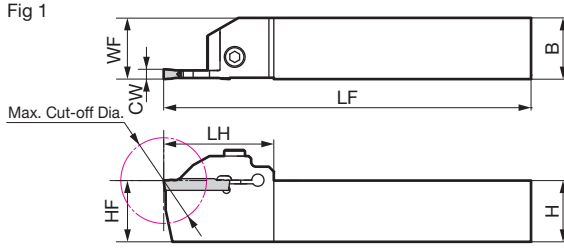
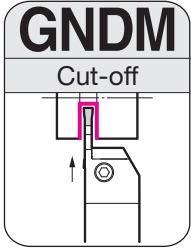

Figure shows right hand (R) tool.

## Holder

## Parts

Dimensions (mm)

Cat. No.	Stock		Height H	Width B	Overall Length LF	Cutting Edge Distance WF	Cutting Edge Height HF	Head LH	Width of Cut CW	Max. Cut-off Dia.	Applicable Insert	Fig	Screw		Wrench
	R	L											BX0520	N-m	
GNDM R/L2020K-1.2510	●	●	20	20	125	20	20	34.0	1.25	20	GCM N125005-GF	1	BX0520	5.0	LH040
GNDM R/L2020K-1.510	●	●	20	20	125	20	20	34.0	1.50	20	GCM N150005-GF	1			
GNDM R/L2020K-210	●	●	20	20	125	20	20	33.6	2.00	20	GC □ 20○○-□□	1			
GNDM R/L2020K-312	●	●	20	20	125	20	20	36.6	3.00	24	GC □ 30○○-□□	1			
GNDM R/L2020K-418	●	●	20	20	125	20	20	45.0	4.00	36	GC □ 40○○-□□	1			
GNDM R/L2020K-518	●	●	20	20	125	20	20	45.0	5.00	36	GC □ N50○○-□□	1			
GNDM R/L2020K-618	●	●	20	20	125	20	20	45.0	6.00	36	GC □ N60○○-□□	1			
GNDM R/L2525M-1.2510	●	●	25	25	150	25	25	36.0	1.25	20	GCM N125005-GF	1	BX0520	5.0	LH040
GNDM R/L2525M-1.510	●	●	25	25	150	25	25	36.0	1.50	20	GCM N150005-GF	1			
GNDM R/L2525M-210	●	●	25	25	150	25	25	33.6	2.00	20	GC □ 20○○-□□	1			
GNDM R/L2525M-312	●	●	25	25	150	25	25	36.6	3.00	24	GC □ 30○○-□□	1			
GNDM R/L2525M-418	●	●	25	25	150	25	25	45.0	4.00	36	GC □ 40○○-□□	1			
GNDM R/L2525M-518	●	●	25	25	150	25	25	45.0	5.00	36	GC □ N50○○-□□	1			
GNDM R/L2525M-618	●	●	25	25	150	25	25	45.0	6.00	36	GC □ N60○○-□□	1			
GNDM R/L3225P-312			32	25	170	25	32	36.6	3.00	24	GC □ 30○○-□□	1	BX0520	5.0	LH040
GNDM R/L3225P-418			32	25	170	25	32	45.0	4.00	36	GC □ 40○○-□□	1			
GNDM R/L3225P-518			32	25	170	25	32	45.0	5.00	36	GC □ N50○○-□□	1			
GNDM R/L3225P-618			32	25	170	25	32	45.0	6.00	36	GC □ N60○○-□□	1	BX0620	6.0	LH050
GNDM R/L3225P-718			32	25	170	25	32	50.0	7.00	36	GCM N70○○-□□	1			
GNDM R/L3225P-818			32	25	170	25	32	50.0	8.00	36	GCM N80○○-□□	1			
GNDM R/L3232P-312	●	●	32	32	170	32	32	36.6	3.00	24	GC □ 30○○-□□	1	BX0620	6.0	LH050
GNDM R/L3232P-418	●	●	32	32	170	32	32	45.0	4.00	36	GC □ 40○○-□□	1			
GNDM R/L3232P-518	●	●	32	32	170	32	32	45.0	5.00	36	GC □ N50○○-□□	1			
GNDM R/L3232P-618	●	●	32	32	170	32	32	45.0	6.00	36	GC □ N60○○-□□	1			
GNDM R/L3232P-718	●	●	32	32	170	32	32	50.0	7.00	36	GCM N70○○-□□	1			
GNDM R/L3232P-818	●	●	32	32	170	32	32	50.0	8.00	36	GCM N80○○-□□	1			

Combine the insert with a holder such that the width of cut (CW) matches. The maximum cut-off diameter indicated above is for inserts with RE = 0.2 mm. Refer to F81 for applicable inserts.

Grooving Tools

Grooving

Cut-off

Threading

External

Face

Internal

Necking

CBN

# GNDM Type

Expansion

## GNDM Type Inserts

( Coated Carbide/ Cermet/ Cemented Carbide)

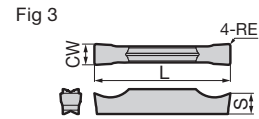
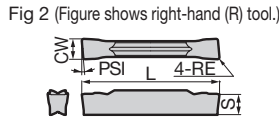
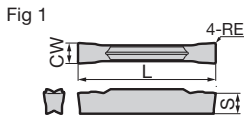

### Grooving / Traverse Cutting

Dimensions (mm)

Cat. No.	Material Compatibility										Width of Cut CW			Corner Radius RE	Overall Length L	Thickness S	Pcs/Pack	Fig
	AC8025P	AC8039P	AC830P	AC425K	AC5015S	AC5025S	AC520U	AC530U	T2500A		Width of Cut	Tolerance						
	●	●	●	●	●	●	●	●	●	●	RE	L	S					
GCM N3002-MG	●	●	●	●	●	●	●	●	●	●	3.0	±0.03	0.2	21.1	3.8	5	1	
N3004-MG	●	●	●	●	●	●	●	●	●	3.0	±0.03	0.4	21.1	3.8				
GCM N4002-MG	●	●	●	●	●	●	●	●	●	●	4.0	±0.03	0.2	26.4	4.0	5	1	
N4004-MG	●	●	●	●	●	●	●	●	●	4.0	±0.03	0.4	26.4	4.0				
N4008-MG	●	●	●	●	●	●	●	●	●	●	4.0	±0.03	0.8	26.4	4.0	5	1	
GCM N5004-MG	●	●	●	●	●	●	●	●	●	●	5.0	±0.03	0.4	26.4	4.1			
N5008-MG	●	●	●	●	●	●	●	●	●	●	5.0	±0.03	0.8	26.4	4.1	5	1	
GCM N6004-MG	●	●	●	●	●	●	●	●	●	●	6.0	±0.03	0.4	26.4	4.5			
N6008-MG	●	●	●	●	●	●	●	●	●	●	6.0	±0.03	0.8	26.4	4.5	5	1	
GCM N7004-MG	●	●	●	●	●	●	●	●	●	●	7.0	±0.04	0.4	28.8	5.5			
N7008-MG	●	●	●	●	●	●	●	●	●	●	7.0	±0.04	0.8	28.8	5.5	5	1	
GCM N8004-MG	●	●	●	●	●	●	●	●	●	●	8.0	±0.04	0.4	28.8	6.0			
N8008-MG	●	●	●	●	●	●	●	●	●	●	8.0	±0.04	0.8	28.8	6.0	5	1	
GCM N2002-ML	●	●	●	●	●	●	●	●	●	●	2.0	±0.03	0.2	21.1	3.6			
N3002-ML	●	●	●	●	●	●	●	●	●	●	3.0	±0.03	0.2	21.1	3.8	5	1	
N3004-ML	●	●	●	●	●	●	●	●	●	●	3.0	±0.03	0.4	21.1	3.8			
GCM N4002-ML	●	●	●	●	●	●	●	●	●	●	4.0	±0.03	0.2	26.4	4.0	5	1	
N4004-ML	●	●	●	●	●	●	●	●	●	●	4.0	±0.03	0.4	26.4	4.0			
N4008-ML	●	●	●	●	●	●	●	●	●	●	4.0	±0.03	0.8	26.4	4.0	5	1	
GCM N5004-ML	●	●	●	●	●	●	●	●	●	●	5.0	±0.03	0.4	26.4	4.1			
N5008-ML	●	●	●	●	●	●	●	●	●	●	5.0	±0.03	0.8	26.4	4.1	5	1	
GCM N6004-ML	●	●	●	●	●	●	●	●	●	●	6.0	±0.03	0.4	26.4	4.5			
N6008-ML	●	●	●	●	●	●	●	●	●	●	6.0	±0.03	0.8	26.4	4.5	5	1	
GCM N7004-ML	●	●	●	●	●	●	●	●	●	●	7.0	±0.04	0.4	28.8	5.5			
N7008-ML	●	●	●	●	●	●	●	●	●	●	7.0	±0.04	0.8	28.8	5.5	5	1	
GCM N8004-ML	●	●	●	●	●	●	●	●	●	●	8.0	±0.04	0.4	28.8	6.0			
N8008-ML	●	●	●	●	●	●	●	●	●	●	8.0	±0.04	0.8	28.8	6.0	5	1	

### Cut-off (Handed Edge)

Dimensions (mm)

Cat. No.	Material Compatibility										Lead Angle PSI	Width of Cut CW			Corner Radius RE	Overall Length L	Thickness S	Pcs/Pack	Fig
	AC8025P	AC8039P	AC830P	AC5015S	AC5025S	AC520U	AC530U	AC1030U	Width of Cut	Tolerance									
	●	●	●	●	●	●	●	●	RE	L		S							
GCM R2002-CG-05	●	●	●	●	●	●	●	●	●	●	5°	2.0	±0.03	0.2	21.1	3.6	5	2	
L2002-CG-05	●	●	●	●	●	●	●	●	●	●	5°	2.0	±0.03	0.2	21.1	3.6			
GCM R3002-CG-05	●	●	●	●	●	●	●	●	●	●	5°	3.0	±0.03	0.2	21.3	3.8	5	2	
L3002-CG-05	●	●	●	●	●	●	●	●	●	●	5°	3.0	±0.03	0.2	21.3	3.8			
GCM R4002-CG-05	●	●	●	●	●	●	●	●	●	●	5°	4.0	±0.04	0.2	26.7	4.0	5	2	
L4002-CG-05	●	●	●	●	●	●	●	●	●	●	5°	4.0	±0.04	0.2	26.7	4.0			
GCM R2003-CF-10	●	●	●	●	●	●	●	●	●	●	10°	2.0	±0.08	0.03	22.4	3.6	5	2	
L2003-CF-10	●	●	●	●	●	●	●	●	●	●	10°	2.0	±0.08	0.03	22.4	3.6			
GCM R3003-CF-10	●	●	●	●	●	●	●	●	●	●	10°	3.0	±0.08	0.03	22.4	3.8	5	2	
L3003-CF-10	●	●	●	●	●	●	●	●	●	●	10°	3.0	±0.08	0.03	22.4	3.8			
GCM R2003-CF-15	●	●	●	●	●	●	●	●	●	●	15°	2.0	±0.08	0.03	22.4	3.6	5	2	
L2003-CF-15	●	●	●	●	●	●	●	●	●	●	15°	2.0	±0.08	0.03	22.4	3.6			
GCM R3003-CF-15	●	●	●	●	●	●	●	●	●	●	15°	3.0	±0.08	0.03	22.4	3.8	5	2	
L3003-CF-15	●	●	●	●	●	●	●	●	●	●	15°	3.0	±0.08	0.03	22.4	3.8			

GCMR: Right Handed, GCML: Left Handed

### Non-Ferrous Metals

Dimensions (mm)

Cat. No.	H10	Material Compatibility										Width of Cut CW			Corner Radius RE	Overall Length L	Thickness S	Pcs/Pack	Fig
		AC8025P	AC8039P	AC830P	AC5015S	AC5025S	AC520U	AC530U	AC1030U	Width of Cut	Tolerance								
		●	●	●	●	●	●	●	●	RE	L	S							
GCG N2002-GA	●	●	●	●	●	●	●	●	●	●	2.0	±0.025	0.2	21.1	3.6	5	3		
N3002-GA	●	●	●	●	●	●	●	●	●	●	3.0	±0.025	0.2	21.1	3.8				
GCG N4004-GA	●	●	●	●	●	●	●	●	●	●	4.0	±0.025	0.4	26.4	4.0	5	3		
N5004-GA	●	●	●	●	●	●	●	●	●	●	5.0	±0.025	0.4	26.4	4.1				
N6004-GA	●	●	●	●	●	●	●	●	●	●	6.0	±0.025	0.4	26.4	4.5	5	3		

### Grooving / Cut-off

Dimensions (mm)

Cat. No.	Material Compatibility										Width of Cut CW			Corner Radius RE	Overall Length L	Thickness S	Pcs/Pack	Fig
	AC8025P	AC8039P	AC830P	AC425K	AC5015S	AC5025S	AC520U	AC530U	T2500A		Width of Cut	Tolerance						
	●	●	●	●	●	●	●	●	●	●	RE	L	S					
GCM N2002-GG	●	●	●	●	●	●	●	●	●	●	2.0	±0.03	0.2	21.1	3.6	5	1	
GCM N3002-GG	●	●	●	●	●	●	●	●	●	●	3.0	±0.03	0.2	21.1	3.8			
N3004-GG	●	●	●	●	●	●	●	●	●	●	3.0	±0.03	0.4	21.1	3.8	5	1	
GCM N4002-GG	●	●	●	●	●	●	●	●	●	●	4.0	±0.03	0.2	26.4	4.0			
N4004-GG	●	●	●	●	●	●	●	●	●	●	4.0	±0.03	0.4	26.4	4.0	5	1	
GCM N5002-GG	●	●	●	●	●	●	●	●	●	●	5.0	±0.03	0.2	26.4	4.1			
N5004-GG	●	●	●	●	●	●	●	●	●	●	5.0	±0.03	0.4	26.4	4.1	5	1	
GCM N6002-GG	●	●	●	●	●	●	●	●	●	●	6.0	±0.03	0.2	26.4	4.5			
N6004-GG	●	●	●	●	●	●	●	●	●	●	6.0	±0.03	0.4	26.4	4.5	5	1	
GCM N7004-GG	●	●	●	●	●	●	●	●	●	●	7.0	±0.04	0.4	28.8	5.5			
N8004-GG	●	●	●	●	●	●	●	●	●	●	8.0	±0.04	0.4	28.8	6.0	5	1	
GCM N2002-GL	●	●	●	●	●	●	●	●	●	●	2.0	±0.03	0.2	21.1	3.6			
N2004-GL	●	●	●	●	●	●	●	●	●	●	2.0	±0.03	0.4	21.1	3.6	5	1	
GCM N3002-GL	●	●	●	●	●	●	●	●	●	●	3.0	±0.03	0.2	21.1	3.8			
N3004-GL	●	●	●	●	●	●	●	●	●	●	3.0	±0.03	0.4	21.1	3.8	5	1	
GCM N4002-GL	●	●	●	●	●	●	●	●	●	●	4.0	±0.03	0.2	26.4	4.0			
N4004-GL	●	●	●	●	●	●	●	●	●	●	4.0	±0.03	0.4	26.4	4.0	5	1	
GCM N5002-GL	●	●	●	●	●	●	●	●	●	●	5.0	±0.03	0.2	26.4	4.1			
N5004-GL	●	●	●	●	●	●	●	●	●	●	5.0	±0.03	0.4	26.4	4.1	5	1	
GCM N6002-GL	●	●	●	●	●	●	●	●	●	●	6.0	±0.03	0.2	26.4	4.5			
N6004-GL	●	●	●	●	●	●	●	●	●	●	6.0	±0.03	0.4	26.4	4.5	5	1	
GCM N7004-GL	●	●	●	●	●	●	●	●	●	●	7.0	±0.04	0.4	28.8	5.5			
N8004-GL	●	●	●	●	●	●	●	●	●	●	8.0	±0.04	0.4	28.8	6.0	5	1	
GCM N125005-GF	●	●	●	●	●	●	●	●	●	●	1.25	±0.03	0.05	17.4	3.2			
N150005-GF	●	●	●	●	●	●	●	●	●	●	1.5	±0.03	0.05	17.4	3.7	5	1	
GCM N2002-GF	●	●	●															

# GNDM-J Type



Grooving Tools

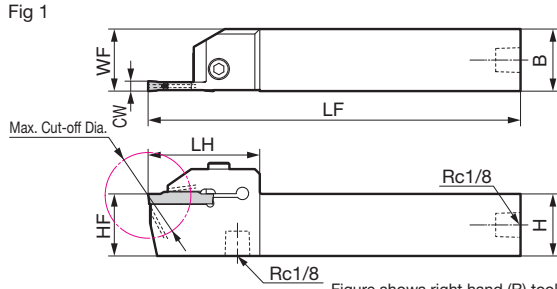
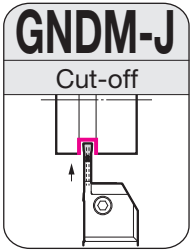

## Holder

## Parts

Dimensions (mm)

Cat. No.	Stock		Height H	Width B	Overall Length LF	Cutting Edge Distance WF	Cutting Edge Height HF	Head LH	Width of Cut CW	Max. Cut-off Dia.	Applicable Insert	Fig	Cap Screw	Plug	Wrench	
	R	L											(N·m)			
<b>GNDM R/L2020K-210J</b>	●	●	20	20	125	20	20	33.6	<b>2.00</b>	<b>20</b>	GC □ 20 ○ ○ - □ □	1	BX0520	6.0	XP02	LH040
<b>R/L2020K-312J</b>	●	●	20	20	125	20	20	36.6	<b>3.00</b>	<b>24</b>	GC □ 30 ○ ○ - □ □	1				
<b>R/L2020K-418J</b>	●	●	20	20	125	20	20	45	<b>4.00</b>	<b>36</b>	GC □ 40 ○ ○ - □ □	1				
<b>R/L2020K-518J</b>	●	●	20	20	125	20	20	45	<b>5.00</b>	<b>36</b>	GC □ N50 ○ ○ - □ □	1				
<b>R/L2020K-618J</b>	●	●	20	20	125	20	20	45	<b>6.00</b>	<b>36</b>	GC □ N60 ○ ○ - □ □	1				
<b>GNDM R/L2525K-210J</b>	●	●	25	25	125	25	25	33.6	<b>2.00</b>	<b>20</b>	GC □ 20 ○ ○ - □ □	1	BX0520	6.0	XP02	LH040
<b>R/L2525K-312J</b>	●	●	25	25	125	25	25	36.6	<b>3.00</b>	<b>24</b>	GC □ 30 ○ ○ - □ □	1				
<b>R/L2525K-418J</b>	●	●	25	25	125	25	25	45	<b>4.00</b>	<b>36</b>	GC □ 40 ○ ○ - □ □	1				
<b>R/L2525K-518J</b>	●	●	25	25	125	25	25	45	<b>5.00</b>	<b>36</b>	GC □ N50 ○ ○ - □ □	1				
<b>R/L2525K-618J</b>	●	●	25	25	125	25	25	45	<b>6.00</b>	<b>36</b>	GC □ N60 ○ ○ - □ □	1				

Combine the insert with a holder such that the width of cut (CW) matches. The maximum cut-off diameter indicated above is for inserts with RE = 0.2 mm. Refer to F83 for applicable inserts.

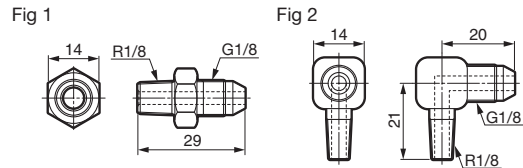
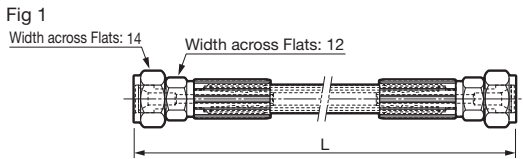

## Parts (Hose)

Dimensions (mm)

Cat. No.	Stock	L	Screw Standard	Screw Standard	Fig
<b>J-HOSE-G1/8-G1/8-200</b>	●	200	G1/8	G1/8	1
<b>J-HOSE-G1/8-G1/8-300</b>	●	300	G1/8	G1/8	1

Hoses are sold separately.

Piping Method for Hoses and Connectors **F23**

## Parts (Connector)

Dimensions (mm)

Cat. No.	Stock	Screw Standard	Screw Standard	Fig
<b>J-G1/8-R1/8-00</b>	●	G1/8	R1/8	1
<b>J-G1/8-R1/8-90</b>	●	G1/8	R1/8	2

Connectors are sold separately.

Piping Method for Hoses and Connectors **F23**

Grooving

Cut-off

Threading

External

Face

Internal

Necking

CBN

# GNDM-J Type



## GNDM-J Type Inserts

(      Coated Carbide/      Cermet/  Cemented Carbide)

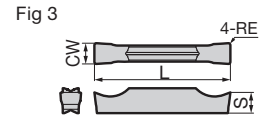
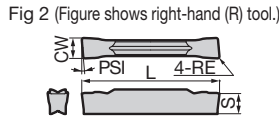
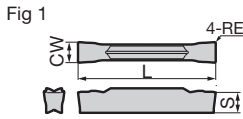

### Grooving / Traverse Cutting

Dimensions (mm)

Cat. No.	Width of Cut CW							Corner Radius RE	Overall Length L	Thickness S	Pcs/Pack	Fig
	Width of Cut		Tolerance									
	RE	L	S	AC8025P	AC8035P	AC830P	AC425K					
GCM N3002-MG N3004-MG	3.0	±0.03	0.2	21.1	3.8	1	1	1	1	1	1	1
GCM N4002-MG N4004-MG N4008-MG	4.0	±0.03	0.2	26.4	4.0	5	1	1	1	1	1	1
GCM N5004-MG N5008-MG	5.0	±0.03	0.4	26.4	4.1	1	1	1	1	1	1	1
GCM N6004-MG N6008-MG	6.0	±0.03	0.4	26.4	4.5	1	1	1	1	1	1	1
GCM N2002-ML N3002-ML N3004-ML	2.0	±0.03	0.2	21.1	3.6	1	1	1	1	1	1	1
GCM N4002-ML N4004-ML N4008-ML	4.0	±0.03	0.2	26.4	4.0	5	1	1	1	1	1	1
GCM N5004-ML N5008-ML	5.0	±0.03	0.4	26.4	4.1	1	1	1	1	1	1	1
GCM N6004-ML N6008-ML	6.0	±0.03	0.4	26.4	4.5	1	1	1	1	1	1	1

### Cut-off (Handed Edge)

Dimensions (mm)

Cat. No.	Width of Cut CW							Lead Angle PSI	Corner Radius RE	Overall Length L	Thickness S	Pcs/Pack	Fig
	Width of Cut		Tolerance										
	RE	L	S	AC8025P	AC8035P	AC5015S	AC5025S						
GCM R2002-CG-05 L2002-CG-05	2.0	±0.03	0.2	21.1	3.6	2	2	5°	2.0	±0.03	0.2	21.1	3.6
GCM R3002-CG-05 L3002-CG-05	3.0	±0.03	0.2	21.3	3.8	5	2	5°	3.0	±0.03	0.2	21.3	3.8
GCM R4002-CG-05 L4002-CG-05	4.0	±0.04	0.2	26.7	4.0	2	2	5°	4.0	±0.04	0.2	26.7	4.0
GCM R2003-CF-10 L2003-CF-10	2.0	±0.08	0.03	22.4	3.6	2	2	10°	2.0	±0.08	0.03	22.4	3.6
GCM R3003-CF-10 L3003-CF-10	3.0	±0.08	0.03	22.4	3.8	2	2	10°	3.0	±0.08	0.03	22.4	3.8
GCM R2003-CF-15 L2003-CF-15	2.0	±0.08	0.03	22.4	3.6	2	2	15°	2.0	±0.08	0.03	22.4	3.6
GCM R3003-CF-15 L3003-CF-15	3.0	±0.08	0.03	22.4	3.8	2	2	15°	3.0	±0.08	0.03	22.4	3.8

GCMR: Right Handed, GCML: Left Handed

### Grooving / Cut-off

Dimensions (mm)

Cat. No.	Width of Cut CW							Corner Radius RE	Overall Length L	Thickness S	Pcs/Pack	Fig
	Width of Cut		Tolerance									
	RE	L	S	AC8025P	AC8035P	AC830P	AC425K					
GCM N2002-GG N3002-GG N3004-GG	2.0	±0.03	0.2	21.1	3.6	1	1	1	1	1	1	1
GCM N4002-GG N4004-GG	4.0	±0.03	0.2	26.4	4.0	5	1	1	1	1	1	1
GCM N5002-GG N5004-GG	5.0	±0.03	0.2	26.4	4.1	1	1	1	1	1	1	1
GCM N6002-GG N6004-GG	6.0	±0.03	0.2	26.4	4.5	1	1	1	1	1	1	1
GCM N2002-GL N2004-GL	2.0	±0.03	0.2	21.1	3.6	1	1	1	1	1	1	1
GCM N3002-GL N3004-GL	3.0	±0.03	0.2	21.1	3.8	1	1	1	1	1	1	1
GCM N4002-GL N4004-GL	4.0	±0.03	0.2	26.4	4.0	5	1	1	1	1	1	1
GCM N5002-GL N5004-GL	5.0	±0.03	0.2	26.4	4.1	1	1	1	1	1	1	1
GCM N6002-GL N6004-GL	6.0	±0.03	0.2	26.4	4.5	1	1	1	1	1	1	1
GCM N2002-GF N2004-GF	2.0	±0.03	0.2	21.1	3.6	1	1	1	1	1	1	1
GCM N3002-GF N3004-GF	3.0	±0.03	0.2	21.1	3.8	1	1	1	1	1	1	1
GCM N4002-GF N4004-GF	4.0	±0.03	0.2	26.4	4.0	5	1	1	1	1	1	1
GCM N5002-GF N5004-GF	5.0	±0.03	0.2	26.4	4.1	1	1	1	1	1	1	1
GCM N6002-GF N6004-GF	6.0	±0.03	0.2	26.4	4.5	1	1	1	1	1	1	1

### Non-Ferrous Metals

Dimensions (mm)

Cat. No.	H10	Width of Cut CW							Corner Radius RE	Overall Length L	Thickness S	Pcs/Pack	Fig
		Width of Cut		Tolerance									
RE	L	S	AC8025P	AC8035P	AC5015S	AC5025S	AC520U	AC530U	AC1030U				
GCG N2002-GA N3002-GA	●	2.0	±0.025	0.2	21.1	3.6	3	3	3	3	3	3	
GCG N4004-GA N5004-GA N6004-GA	●	4.0	±0.025	0.4	26.4	4.0	5	3	3	3	3	3	

### Part Number Suffix Code (Chipbreakers)

Type	Symbol	Applications	Type	Symbol	Applications
Grooving/ Traverse Cutting	MG ML	Multi-functional / General-purpose Multi-functional / Low-feed	Cut-off (Handed Edge)	CG CF	Cut-off / General-purpose Cut-off / Low-resistance
Grooving / Cut-off	GG GL GF	Grooving / General-purpose Grooving / Low Feed Grooving / Low-resistance	For Non-Ferrous Metals	GA	Non-Ferrous Metals / General-purpose

Chipbreaker Selection **F13** Important Notes **F22** Recommended Cutting Conditions **F19**

Select holders and inserts with matching width of cut (CW). Not usable with GNDIS type holders.

● mark: Standard stocked item (new product/expanded item)

Grooving  
Tools

L

Grooving

Cut-off

Threading

External

Face

Internal

Necking

CBN

# GNDL Type

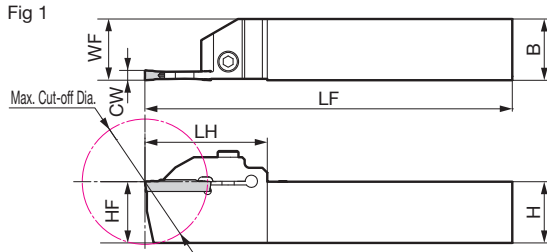
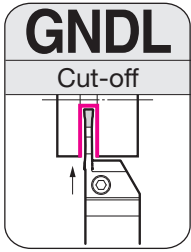

Figure shows right hand (R) tool.

## Holder

## Parts

Dimensions (mm)

Cat. No.	Stock		Height H	Width B	Overall Length LF	Cutting Edge Distance WF	Cutting Edge Height HF	Head LH	Width of Cut CW	Max. Cut- off Dia.	Applicable Insert	Fig	Cap Screw		Wrench
	R	L											BX0520 	N-m 	
GNDL R/L2020K-1.2516	●	●	20	20	125	20	20	38.0	1.25	32	GCM N125005-GF	1	BX0520	5.0	LH040
GNDL R/L2020K-1.516	●	●	20	20	125	20	20	38.0	1.50	32	GCM N150005-GF	1			
GNDL R/L2020K-220	●	●	20	20	125	20	20	44.5	2.00	40	GC □ 2000-□□	1			
GNDL R/L2020K-320	●	●	20	20	125	20	20	44.5	3.00	40	GC □ 3000-□□	1			
GNDL R/L2020K-425	●	●	20	20	125	20	20	50.0	4.00	50	GC □ 4000-□□	1			
GNDL R/L2020K-525	●	●	20	20	125	20	20	50.0	5.00	50	GC □ N5000-□□	1			
GNDL R/L2020K-625	●	●	20	20	125	20	20	50.0	6.00	50	GC □ N6000-□□	1			
GNDL R/L2525M-1.2516	●	●	25	25	150	25	25	40.0	1.25	32	GCM N125005-GF	1	BX0520	5.0	LH040
GNDL R/L2525M-1.516	●	●	25	25	150	25	25	40.0	1.50	32	GCM N150005-GF	1			
GNDL R/L2525M-220	●	●	25	25	150	25	25	44.5	2.00	40	GC □ 2000-□□	1			
GNDL R/L2525M-320	●	●	25	25	150	25	25	44.5	3.00	40	GC □ 3000-□□	1			
GNDL R/L2525M-425	●	●	25	25	150	25	25	50.0	4.00	50	GC □ 4000-□□	1			
GNDL R/L2525M-525	●	●	25	25	150	25	25	50.0	5.00	50	GC □ N5000-□□	1			
GNDL R/L2525M-625	●	●	25	25	150	25	25	50.0	6.00	50	GC □ N6000-□□	1			
GNDL R/L3225P-320			32	25	170	25	32	44.5	3.00	40	GC □ 3000-□□	1	BX0520	5.0	LH040
GNDL R/L3225P-425			32	25	170	25	32	50.0	4.00	50	GC □ 4000-□□	1			
GNDL R/L3225P-525			32	25	170	25	32	50.0	5.00	50	GC □ N5000-□□	1			
GNDL R/L3225P-625			32	25	170	25	32	50.0	6.00	50	GC □ N6000-□□	1			
GNDL R/L3225P-725			32	25	170	25	32	50.0	7.00	50	GCM N7000-□□	1			
GNDL R/L3225P-825			32	25	170	25	32	50.0	8.00	50	GCM N8000-□□	1			
GNDL R/L3232P-320	●	●	32	32	170	32	32	44.5	3.00	40	GC □ 3000-□□	1	BX0620	6.0	LH050
GNDL R/L3232P-425	●	●	32	32	170	32	32	50.0	4.00	50	GC □ 4000-□□	1			
GNDL R/L3232P-525	●	●	32	32	170	32	32	50.0	5.00	50	GC □ N5000-□□	1			
GNDL R/L3232P-625	●	●	32	32	170	32	32	50.0	6.00	50	GC □ N6000-□□	1			
GNDL R/L3232P-725	●	●	32	32	170	32	32	50.0	7.00	50	GCM N7000-□□	1			
GNDL R/L3232P-825	●	●	32	32	170	32	32	50.0	8.00	50	GCM N8000-□□	1			

Combine the insert with a holder such that the width of cut (CW) matches. The maximum cut-off diameter indicated above is for inserts with RE = 0.2 mm. Refer to F85 for applicable inserts.

Grooving Tools

Grooving

Cut-off

Threading

External

Face

Internal

Necking

CBN



# GNDL Type

Expansion GNDL Type Inserts

( Coated Carbide/ Cermet/ Cemented Carbide)

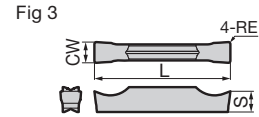
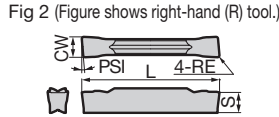
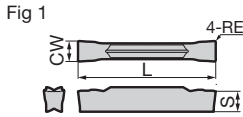

### Grooving / Traverse Cutting

Dimensions (mm)

Cat. No.	Material Compatibility										Width of Cut CW			Corner Radius	Overall Length	Thickness	Pcs/Pack	Fig
	AC8025P	AC8039P	AC830P	AC425K	AC5015S	AC5025S	AC520U	AC530U	T2500A	RE	L	S						
	Width of Cut	Tolerance	RE	L	S													
GCM N3002-MG	●	●	●	●	●	●	●	●	●	●	3.0	±0.03	0.2	21.1	3.8	5	1	
N3004-MG	●	●	●	●	●	●	●	●	●	●	3.0	±0.03	0.4	21.1	3.8		1	
GCM N4002-MG	●	●	●	●	●	●	●	●	●	●	4.0	±0.03	0.2	26.4	4.0	1		
N4004-MG	●	●	●	●	●	●	●	●	●	●	4.0	±0.03	0.4	26.4	4.0	1		
N4008-MG	●	●	●	●	●	●	●	●	●	●	4.0	±0.03	0.8	26.4	4.0	1		
GCM N5004-MG	●	●	●	●	●	●	●	●	●	●	5.0	±0.03	0.4	26.4	4.1	1		
N5008-MG	●	●	●	●	●	●	●	●	●	●	5.0	±0.03	0.8	26.4	4.1	1		
GCM N6004-MG	●	●	●	●	●	●	●	●	●	●	6.0	±0.03	0.4	26.4	4.5	1		
N6008-MG	●	●	●	●	●	●	●	●	●	●	6.0	±0.03	0.8	26.4	4.5	1		
GCM N7004-MG	●	●	●	●	●	●	●	●	●	●	7.0	±0.04	0.4	28.8	5.5	1		
N7008-MG	●	●	●	●	●	●	●	●	●	●	7.0	±0.04	0.8	28.8	5.5	1		
GCM N8004-MG	●	●	●	●	●	●	●	●	●	●	8.0	±0.04	0.4	28.8	6.0	1		
N8008-MG	●	●	●	●	●	●	●	●	●	●	8.0	±0.04	0.8	28.8	6.0	1		
GCM N2002-ML	●	●	●	●	●	●	●	●	●	●	2.0	±0.03	0.2	21.1	3.6	1		
N3002-ML	●	●	●	●	●	●	●	●	●	●	3.0	±0.03	0.2	21.1	3.8	1		
N3004-ML	●	●	●	●	●	●	●	●	●	●	3.0	±0.03	0.4	21.1	3.8	1		
GCM N4002-ML	●	●	●	●	●	●	●	●	●	●	4.0	±0.03	0.2	26.4	4.0	1		
N4004-ML	●	●	●	●	●	●	●	●	●	●	4.0	±0.03	0.4	26.4	4.0	1		
N4008-ML	●	●	●	●	●	●	●	●	●	●	4.0	±0.03	0.8	26.4	4.0	1		
GCM N5004-ML	●	●	●	●	●	●	●	●	●	●	5.0	±0.03	0.4	26.4	4.1	1		
N5008-ML	●	●	●	●	●	●	●	●	●	●	5.0	±0.03	0.8	26.4	4.1	1		
GCM N6004-ML	●	●	●	●	●	●	●	●	●	●	6.0	±0.03	0.4	26.4	4.5	1		
N6008-ML	●	●	●	●	●	●	●	●	●	●	6.0	±0.03	0.8	26.4	4.5	1		
GCM N7004-ML	●	●	●	●	●	●	●	●	●	●	7.0	±0.04	0.4	28.8	5.5	1		
N7008-ML	●	●	●	●	●	●	●	●	●	●	7.0	±0.04	0.8	28.8	5.5	1		
GCM N8004-ML	●	●	●	●	●	●	●	●	●	●	8.0	±0.04	0.4	28.8	6.0	1		
N8008-ML	●	●	●	●	●	●	●	●	●	●	8.0	±0.04	0.8	28.8	6.0	1		

### Cut-off (Handed Edge)

Dimensions (mm)

Cat. No.	Material Compatibility										Lead Angle	Width of Cut CW			Corner Radius	Overall Length	Thickness	Pcs/Pack	Fig
	AC8025P	AC8039P	AC830P	AC5015S	AC5025S	AC520U	AC530U	ACT1030U	RE	L		S							
	Width of Cut	Tolerance	RE	L	S														
GCM R2002-CG-05	●	●	●	●	●	●	●	●	●	●	5°	2.0	±0.03	0.2	21.1	3.6	5	2	
L2002-CG-05	●	●	●	●	●	●	●	●	●	●	5°	2.0	±0.03	0.2	21.1	3.6		2	
GCM R3002-CG-05	●	●	●	●	●	●	●	●	●	●	5°	3.0	±0.03	0.2	21.3	3.8	2		
L3002-CG-05	●	●	●	●	●	●	●	●	●	●	5°	3.0	±0.03	0.2	21.3	3.8	2		
GCM R4002-CG-05	●	●	●	●	●	●	●	●	●	●	5°	4.0	±0.04	0.2	26.7	4.0	2		
L4002-CG-05	●	●	●	●	●	●	●	●	●	●	5°	4.0	±0.04	0.2	26.7	4.0	2		
GCM R2003-CF-10	●	●	●	●	●	●	●	●	●	●	10°	2.0	±0.08	0.03	22.4	3.6	5	2	
L2003-CF-10	●	●	●	●	●	●	●	●	●	●	10°	2.0	±0.08	0.03	22.4	3.6		2	
GCM R3003-CF-10	●	●	●	●	●	●	●	●	●	●	10°	3.0	±0.08	0.03	22.4	3.8	2		
L3003-CF-10	●	●	●	●	●	●	●	●	●	●	10°	3.0	±0.08	0.03	22.4	3.8	2		
GCM R2003-CF-15	●	●	●	●	●	●	●	●	●	●	15°	2.0	±0.08	0.03	22.4	3.6	5	2	
L2003-CF-15	●	●	●	●	●	●	●	●	●	●	15°	2.0	±0.08	0.03	22.4	3.6		2	
GCM R3003-CF-15	●	●	●	●	●	●	●	●	●	●	15°	3.0	±0.08	0.03	22.4	3.8	2		
L3003-CF-15	●	●	●	●	●	●	●	●	●	●	15°	3.0	±0.08	0.03	22.4	3.8	2		

GCMR: Right Handed, GCML: Left Handed

### Non-Ferrous Metals

Dimensions (mm)

Cat. No.	H10	Material Compatibility										Width of Cut CW			Corner Radius	Overall Length	Thickness	Pcs/Pack	Fig
		AC8025P	AC8039P	AC830P	AC5015S	AC5025S	AC520U	AC530U	ACT1030U	RE	L	S							
		Width of Cut	Tolerance	RE	L	S													
GCG N2002-GA	●	●	●	●	●	●	●	●	●	●	2.0	±0.025	0.2	21.1	3.6	5	3		
N3002-GA	●	●	●	●	●	●	●	●	●	●	3.0	±0.025	0.2	21.1	3.8		3		
GCG N4004-GA	●	●	●	●	●	●	●	●	●	●	4.0	±0.025	0.4	26.4	4.0	3			
N5004-GA	●	●	●	●	●	●	●	●	●	●	5.0	±0.025	0.4	26.4	4.1	3			
N6004-GA	●	●	●	●	●	●	●	●	●	●	6.0	±0.025	0.4	26.4	4.5	3			

### Grooving / Cut-off

Dimensions (mm)

Cat. No.	Material Compatibility										Width of Cut CW			Corner Radius	Overall Length	Thickness	Pcs/Pack	Fig
	AC8025P	AC8039P	AC830P	AC425K	AC5015S	AC5025S	AC520U	AC530U	T2500A	RE	L	S						
	Width of Cut	Tolerance	RE	L	S													
GCM N2002-GG	●	●	●	●	●	●	●	●	●	●	2.0	±0.03	0.2	21.1	3.6	5	1	
N3002-GG	●	●	●	●	●	●	●	●	●	●	3.0	±0.03	0.2	21.1	3.8		1	
N3004-GG	●	●	●	●	●	●	●	●	●	●	3.0	±0.03	0.4	21.1	3.8	1		
GCM N4002-GG	●	●	●	●	●	●	●	●	●	●	4.0	±0.03	0.2	26.4	4.0	1		
N4004-GG	●	●	●	●	●	●	●	●	●	●	4.0	±0.03	0.4	26.4	4.0	1		
GCM N5002-GG	●	●	●	●	●	●	●	●	●	●	5.0	±0.03	0.2	26.4	4.1	1		
N5004-GG	●	●	●	●	●	●	●	●	●	●	5.0	±0.03	0.4	26.4	4.1	1		
GCM N6002-GG	●	●	●	●	●	●	●	●	●	●	6.0	±0.03	0.2	26.4	4.5	1		
N6004-GG	●	●	●	●	●	●	●	●	●	●	6.0	±0.03	0.4	26.4	4.5	1		
GCM N7004-GG	●	●	●	●	●	●	●	●	●	●	7.0	±0.04	0.4	28.8	5.5	1		
GCM N8004-GG	●	●	●	●	●	●	●	●	●	●	8.0	±0.04	0.4	28.8	6.0	1		
GCM N2002-GL	●	●	●	●	●	●	●	●	●	●	2.0	±0.03	0.2	21.1	3.6	5	1	
N2004-GL	●	●	●	●	●	●	●	●	●	●	2.0	±0.03	0.4	21.1	3.6		1	
GCM N3002-GL	●	●	●	●	●	●	●	●	●	●	3.0	±0.03	0.2	21.1	3.8	1		
N3004-GL	●	●	●	●	●	●	●	●	●	●	3.0	±0.03	0.4	21.1	3.8	1		
GCM N4002-GL	●	●	●	●	●	●	●	●	●	●	4.0	±0.03	0.2	26.4	4.0	1		
N4004-GL	●	●	●	●	●	●	●	●	●	●	4.0	±0.03	0.4	26.4	4.0	1		
GCM N5002-GL	●	●	●	●	●	●	●	●	●	●	5.0	±0.03	0.2	26.4	4.1	1		
N5004-GL	●	●	●	●	●	●	●	●	●	●	5.0	±0.03	0.4	26.4	4.1	1		
GCM N6002-GL	●	●	●	●	●	●	●	●	●	●	6.0	±0.03	0.2	26.4	4.5	1		
N6004-GL	●	●	●	●	●	●	●	●	●	●	6.0	±0.03	0.4	26.4	4.5	1		
GCM N7004-GL	●	●	●	●	●	●	●	●	●	●	7.0	±0.04	0.4	28.8	5.5	1		
GCM N8004-GL	●	●	●	●	●	●	●	●	●	●	8.0	±0.04	0.4	28.8	6.0	1		
GCM N125005-GF	●	●	●	●	●	●	●	●	●	●	1.25	±0.03	0.05	17.4	3.2	1		
N150005-GF	●	●	●	●	●	●	●	●	●	●	1.5	±0.03	0.05	17.4	3.7	1		
GCM N2002-GF	●	●	●	●	●	●	●	●	●	●	2.0	±0.03	0.2	21.1	3.6	5	1	
N2004-GF	●	●	●	●	●	●	●	●	●	●	2.0	±0.03	0.4	21.1	3.6		1	
GCM N3002-GF	●	●	●	●	●	●	●	●	●	●	3.0	±0.03	0.2	21.1	3.8	1		
N3																		

# GNDL-J Type



Grooving Tools

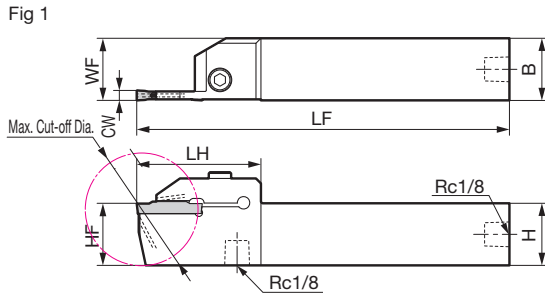
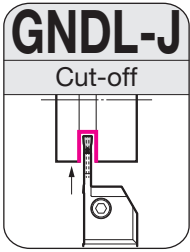

Figure shows right hand (R) tool.

## Holder

## Parts

Dimensions (mm)

Cat. No.	Stock		Height H	Width B	Overall Length LF	Cutting Edge Distance WF	Cutting Edge Height HF	Head Length LH	Width of Cut CW	Max. Cut-off Dia.	Applicable Insert	Fig	Dimensions (mm)			
	R	L											Cap Screw	Plug	Wrench	
<b>GNDL R/L2020K-220J</b>	●	●	20	20	125	20	20	44.5	<b>2.00</b>	<b>40</b>	GC □ 20○○-□□	1	BX0520	6.0	XP02	LH040
<b>R/L2020K-320J</b>	●	●	20	20	125	20	20	44.5	<b>3.00</b>	<b>40</b>	GC □ 30○○-□□	1				
<b>R/L2020K-425J</b>	●	●	20	20	125	20	20	50	<b>4.00</b>	<b>50</b>	GC □ 40○○-□□	1				
<b>R/L2020K-525J</b>	●	●	20	20	125	20	20	50	<b>5.00</b>	<b>50</b>	GC □ N50○○-□□	1				
<b>R/L2020K-625J</b>	●	●	20	20	125	20	20	50	<b>6.00</b>	<b>50</b>	GC □ N60○○-□□	1				
<b>GNDL R/L2525K-220J</b>	●	●	25	25	125	25	25	44.5	<b>2.00</b>	<b>40</b>	GC □ 20○○-□□	1	BX0520	6.0	XP02	LH040
<b>R/L2525K-320J</b>	●	●	25	25	125	25	25	44.5	<b>3.00</b>	<b>40</b>	GC □ 30○○-□□	1				
<b>R/L2525K-425J</b>	●	●	25	25	125	25	25	50	<b>4.00</b>	<b>50</b>	GC □ 40○○-□□	1				
<b>R/L2525K-525J</b>	●	●	25	25	125	25	25	50	<b>5.00</b>	<b>50</b>	GC □ N50○○-□□	1				
<b>R/L2525K-625J</b>	●	●	25	25	125	25	25	50	<b>6.00</b>	<b>50</b>	GC □ N60○○-□□	1				

Combine the insert with a holder such that the width of cut (CW) matches. The maximum cut-off diameter indicated above is for inserts with RE = 0.2 mm. Refer to F87 for applicable inserts.

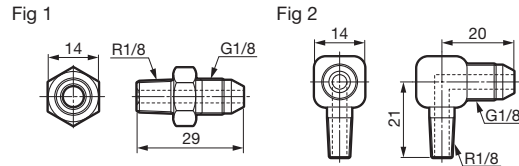
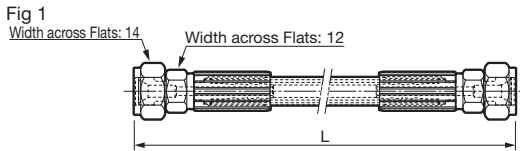

## Parts (Hose)

Dimensions (mm)

Cat. No.	Stock	L	Screw Standard	Screw Standard	Fig
<b>J-HOSE-G1/8-G1/8-200</b>	●	200	G1/8	G1/8	1
<b>J-HOSE-G1/8-G1/8-300</b>	●	300	G1/8	G1/8	1

Hoses are sold separately.

Piping Method for Hoses and Connectors **F23**

## Parts (Connector)

Dimensions (mm)

Cat. No.	Stock	Screw Standard	Screw Standard	Fig
<b>J-G1/8-R1/8-00</b>	●	G1/8	R1/8	1
<b>J-G1/8-R1/8-90</b>	●	G1/8	R1/8	2

Connectors are sold separately.

Piping Method for Hoses and Connectors **F23**



## GNDL-J Type Inserts

( Coated Carbide/ Cermet/ Cemented Carbide)

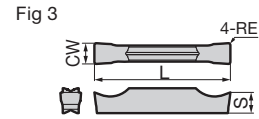
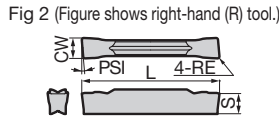
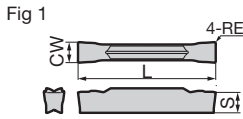

### Grooving / Traverse Cutting

Dimensions (mm)

Cat. No.	Width of Cut CW							Corner Radius RE	Overall Length L	Thickness S	Pcs/Pack	Fig
	Width of Cut		Tolerance									
	RE	L	S	AC8025P	AC8035P	AC830P	AC425K					
GCM N3002-MG N3004-MG	3.0	±0.03	0.2	21.1	3.8	1						
GCM N4002-MG N4004-MG N4008-MG	4.0	±0.03	0.2	26.4	4.0	1						
GCM N5004-MG N5008-MG	5.0	±0.03	0.4	26.4	4.1	1						
GCM N6004-MG N6008-MG	6.0	±0.03	0.4	26.4	4.5	1						
GCM N2002-ML N3002-ML N3004-ML	2.0	±0.03	0.2	21.1	3.6	1						
GCM N4002-ML N4004-ML N4008-ML	4.0	±0.03	0.2	26.4	4.0	1						
GCM N5004-ML N5008-ML	5.0	±0.03	0.4	26.4	4.1	1						
GCM N6004-ML N6008-ML	6.0	±0.03	0.4	26.4	4.5	1						

### Cut-off (Handed Edge)

Dimensions (mm)

Cat. No.	Width of Cut CW							Corner Radius RE	Overall Length L	Thickness S	Pcs/Pack	Fig
	Width of Cut		Tolerance									
	RE	L	S	AC8025P	AC8035P	AC5015S	AC5025S					
GCM R2002-CG-05 L2002-CG-05	2.0	±0.03	0.2	21.1	3.6	2						
GCM R3002-CG-05 L3002-CG-05	3.0	±0.03	0.2	21.3	3.8	2						
GCM R4002-CG-05 L4002-CG-05	4.0	±0.04	0.2	26.7	4.0	2						
GCM R20003-CF-10 L20003-CF-10	2.0	±0.08	0.03	22.4	3.6	2						
GCM R30003-CF-10 L30003-CF-10	3.0	±0.08	0.03	22.4	3.8	2						
GCM R20003-CF-15 L20003-CF-15	2.0	±0.08	0.03	22.4	3.6	2						
GCM R30003-CF-15 L30003-CF-15	3.0	±0.08	0.03	22.4	3.8	2						

GCMR: Right Handed, GCML: Left Handed

### Grooving / Cut-off

Dimensions (mm)

Cat. No.	Width of Cut CW							Corner Radius RE	Overall Length L	Thickness S	Pcs/Pack	Fig
	Width of Cut		Tolerance									
	RE	L	S	AC8025P	AC8035P	AC830P	AC425K					
GCM N2002-GG N3002-GG N3004-GG	2.0	±0.03	0.2	21.1	3.6	1						
GCM N4002-GG N4004-GG	4.0	±0.03	0.2	26.4	4.0	1						
GCM N5002-GG N5004-GG	5.0	±0.03	0.2	26.4	4.1	1						
GCM N6002-GG N6004-GG	6.0	±0.03	0.2	26.4	4.5	1						
GCM N2002-GL N2004-GL	2.0	±0.03	0.2	21.1	3.6	1						
GCM N3002-GL N3004-GL	3.0	±0.03	0.2	21.1	3.8	1						
GCM N4002-GL N4004-GL	4.0	±0.03	0.2	26.4	4.0	1						
GCM N5002-GL N5004-GL	5.0	±0.03	0.2	26.4	4.1	1						
GCM N6002-GL N6004-GL	6.0	±0.03	0.2	26.4	4.5	1						
GCM N2002-GF N2004-GF	2.0	±0.03	0.2	21.1	3.6	1						
GCM N3002-GF N3004-GF	3.0	±0.03	0.2	21.1	3.8	1						
GCM N4002-GF N4004-GF	4.0	±0.03	0.2	26.4	4.0	1						
GCM N5002-GF N5004-GF	5.0	±0.03	0.2	26.4	4.1	1						
GCM N6002-GF N6004-GF	6.0	±0.03	0.2	26.4	4.5	1						

### Non-Ferrous Metals

Dimensions (mm)

Cat. No.	H10	Width of Cut CW							Corner Radius RE	Overall Length L	Thickness S	Pcs/Pack	Fig
		Width of Cut		Tolerance									
		RE	L	S	AC8025P	AC8035P	AC830P	AC425K					
GCG N2002-GA N3002-GA	●	2.0	±0.025	0.2	21.1	3.6	3						
GCG N4004-GA N5004-GA N6004-GA	●	4.0	±0.025	0.4	26.4	4.0	5						

### Part Number Suffix Code (Chipbreakers)

Type	Symbol	Applications	Type	Symbol	Applications
Grooving/ Traverse Cutting	MG ML	Multi-functional / General-purpose Multi-functional / Low-feed	Cut-off (Handed Edge)	CG CF	Cut-off / General-purpose Cut-off / Low-resistance
Grooving / Cut-off	GG GL GF	Grooving / General-purpose Grooving / Low Feed Grooving / Low-resistance	For Non-Ferrous Metals	GA	Non-Ferrous Metals / General-purpose

Chipbreaker Selection **F13** Important Notes **F22** Recommended Cutting Conditions **F19**

Select holders and inserts with matching width of cut (CW). Not usable with GNDIS type holders.

● mark: Standard stocked item (new product/expanded item)

# MEMO

